

18 inch AL10 Module with 60 Degree Clear Lens

<p>DO NOT SCALE DRAWING INTERPRET DRAWING PER ASME 14.5M 1994</p> <p>PROPRIETARY AND CONFIDENTIAL THE INFORMATION CONTAINED IN THIS DRAWING IS THE SOLE PROPERTY OF LUMINATION, LLC. ANY REPRODUCTION IN PART OR AS A WHOLE WITHOUT THE WRITTEN PERMISSION OF LUMINATION, LLC IS PROHIBITED.</p>	<p>1975 Noble Road, Bldg 338 E, East Cleveland, Ohio 44112-6300</p>	DRAWING DESCRIPTION 18 INCH AL10 ASSEMBLY		UNITS OF MEASURE mm
		<p>DRAWN BY Gary Wang</p> <p>DATE 11/25/2009</p> <p>THIS DOCUMENT IS ELECTRONICALLY SIGNED AND CONTROLLED IN A DATA MANAGEMENT SYSTEM</p>	<p>DRAWING NUMBER 30-1310</p> <p>LIFE CYCLE STATUS</p>	REVISION C
		SCALE 1:2	SIZE B	SHEET 1 / 4

5 4 3 2 1

D D



C C

B B

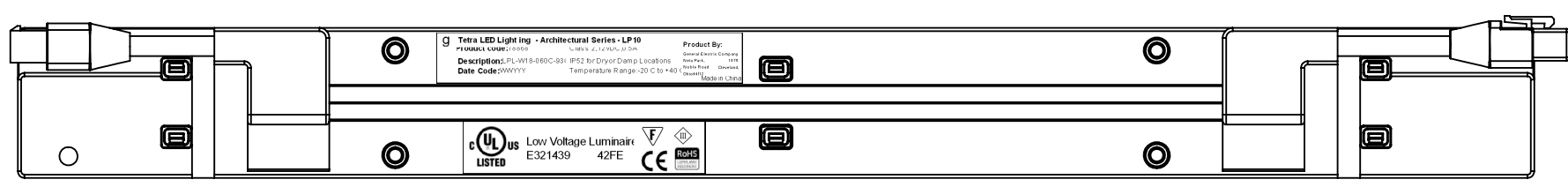
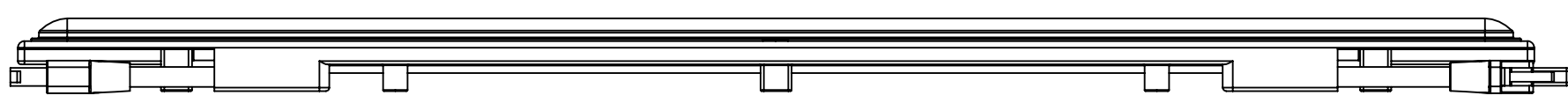
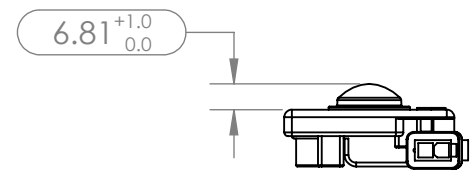
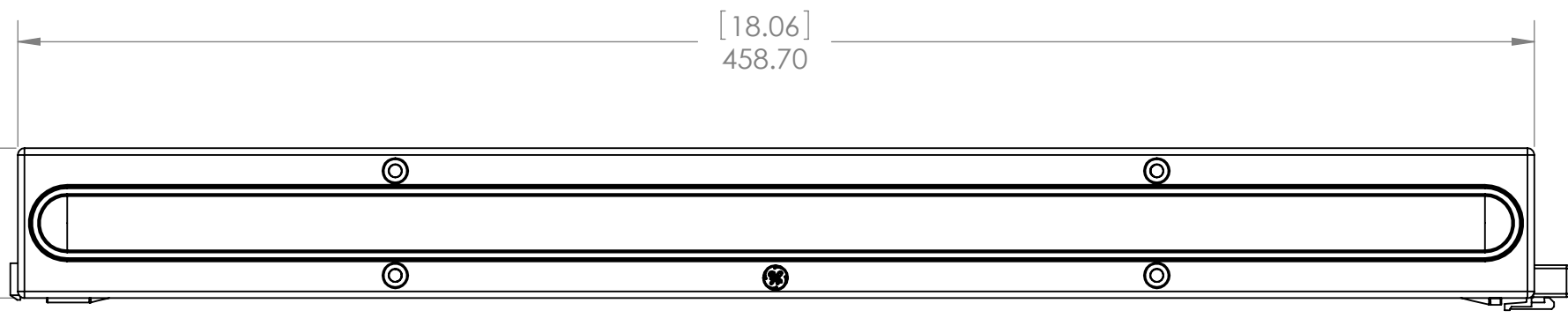
A A





18 inch AL10 Module with 90 Degree Clear Lens

<p>DO NOT SCALE DRAWING INTERPRET DRAWING PER ASME 14.5M 1994</p> <p>PROPRIETARY AND CONFIDENTIAL THE INFORMATION CONTAINED IN THIS DRAWING IS THE SOLE PROPERTY OF LUMINATION, LLC. ANY REPRODUCTION IN PART OR AS A WHOLE WITHOUT THE WRITTEN PERMISSION OF LUMINATION, LLC IS PROHIBITED.</p>	 <p>1975 Noble Road, Bldg 338 E, East Cleveland, Ohio 44112-6300</p>	<p>DRAWING DESCRIPTION 18 INCH AL10 ASSEMBLY</p>		<p>UNITS OF MEASURE mm</p>	
		<p>DRAWN BY Gary Wang</p>	<p>DATE 11/25/2009</p>	<p>DRAWING NUMBER 30-1310</p>	<p>REVISION C</p>
<p>THIS DOCUMENT IS ELECTRONICALLY SIGNED AND CONTROLLED IN A DATA MANAGEMENT SYSTEM</p>			<p>SCALE 1:2</p>	<p>SIZE B</p>	<p>SHEET 2 / 4</p>

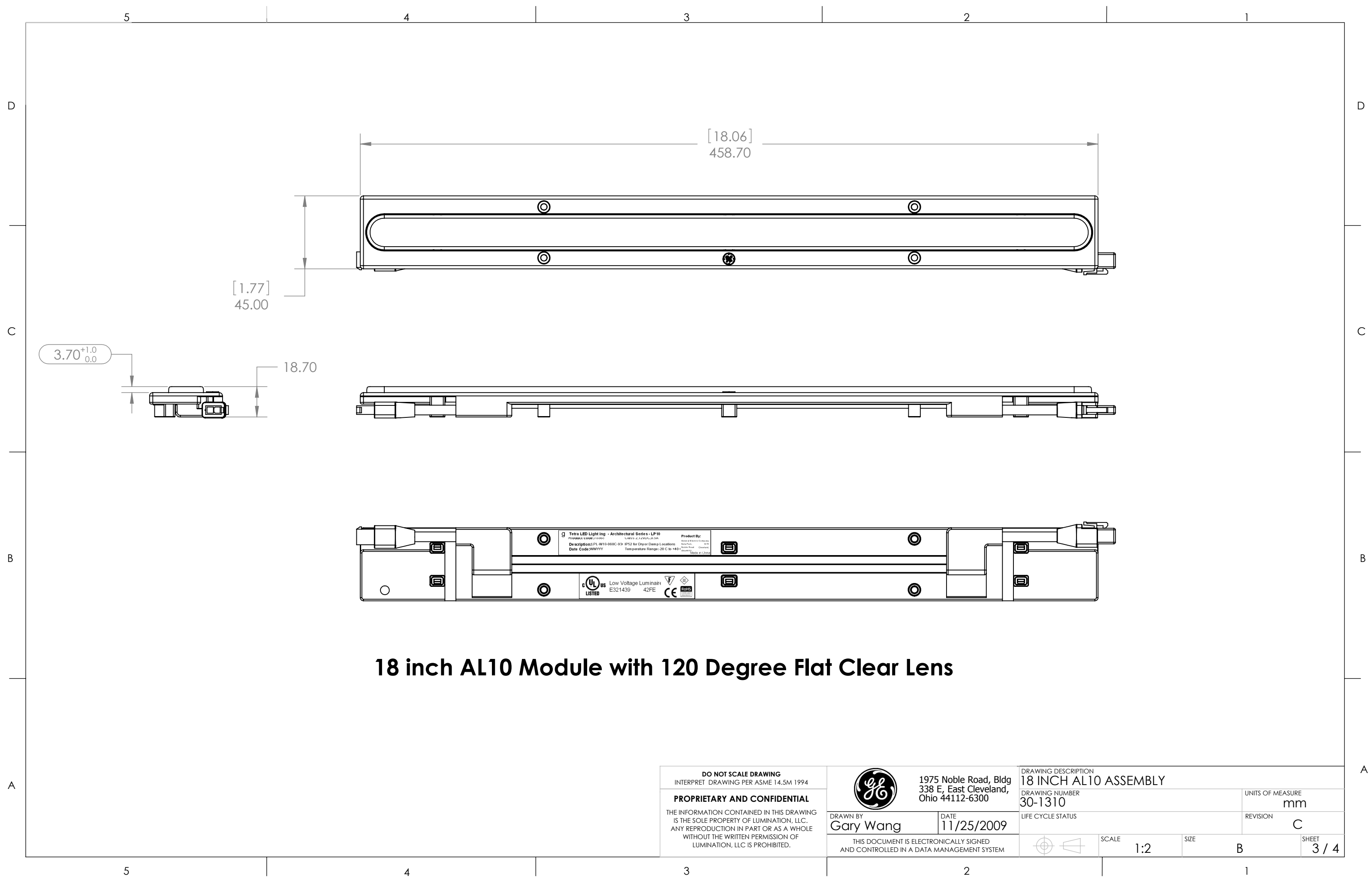
5 4 3 2 1



18 inch AL10 Module with 120 Degree Flat Clear Lens

<p>DO NOT SCALE DRAWING INTERPRET DRAWING PER ASME 14.5M 1994</p> <p>PROPRIETARY AND CONFIDENTIAL THE INFORMATION CONTAINED IN THIS DRAWING IS THE SOLE PROPERTY OF LUMINATION, LLC. ANY REPRODUCTION IN PART OR AS A WHOLE WITHOUT THE WRITTEN PERMISSION OF LUMINATION, LLC IS PROHIBITED.</p>	 <p>1975 Noble Road, Bldg 338 E, East Cleveland, Ohio 44112-6300</p>	<p>DRAWING DESCRIPTION 18 INCH AL10 ASSEMBLY</p>		<p>UNITS OF MEASURE mm</p>	
		<p>DRAWN BY Gary Wang</p>	<p>DATE 11/25/2009</p>	<p>LIFE CYCLE STATUS</p>	<p>REVISION C</p>
<p>THIS DOCUMENT IS ELECTRONICALLY SIGNED AND CONTROLLED IN A DATA MANAGEMENT SYSTEM</p>			<p>SCALE 1:2</p>	<p>SIZE B</p>	<p>SHEET 3 / 4</p>

5 4 3 2 1

D

D

C

C

B

B

A

A

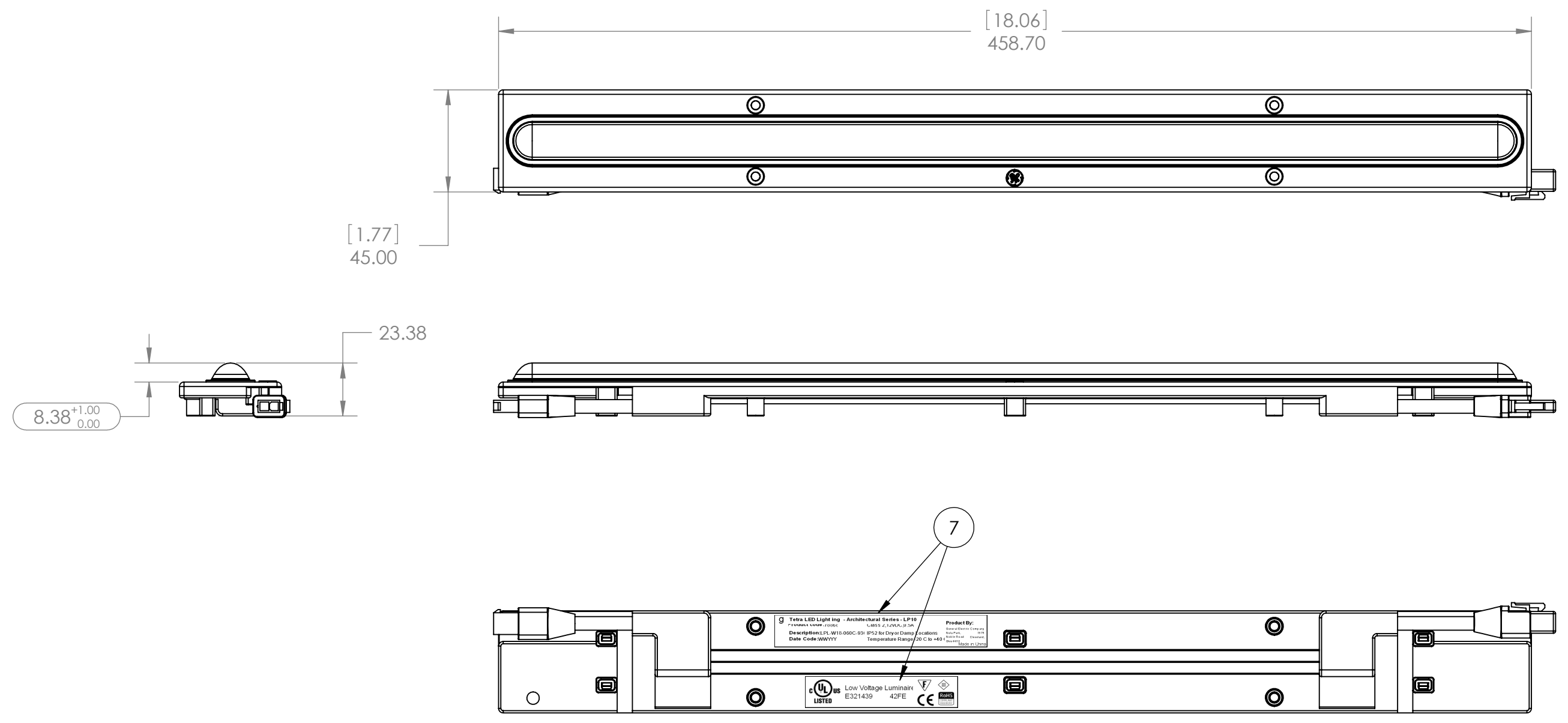

18 inch AL10 Module with Cylinder Diffusion Clear Lens

<p>DO NOT SCALE DRAWING INTERPRET DRAWING PER ASME 14.5M 1994</p> <p>PROPRIETARY AND CONFIDENTIAL THE INFORMATION CONTAINED IN THIS DRAWING IS THE SOLE PROPERTY OF LUMINATION, LLC. ANY REPRODUCTION IN PART OR AS A WHOLE WITHOUT THE WRITTEN PERMISSION OF LUMINATION, LLC IS PROHIBITED.</p>	<p>1975 Noble Road, Bldg 338 E, East Cleveland, Ohio 44112-6300</p>	<p>DRAWING DESCRIPTION 18 INCH AL10 ASEMBLY</p>		<p>UNITS OF MEASURE mm</p>
		<p>DRAWN BY Gary Wang</p>	<p>DATE 11/25/2009</p>	<p>DRAWING NUMBER 30-1310</p>
<p>THIS DOCUMENT IS ELECTRONICALLY SIGNED AND CONTROLLED IN A DATA MANAGEMENT SYSTEM</p>		<p>SCALE 1:2</p>	<p>SIZE B</p>	<p>SHEET 4 / 4</p>

5 4 3 2 1