

GE
Lighting

GE LED Wall Washer

LED Lighting System
LWW Series

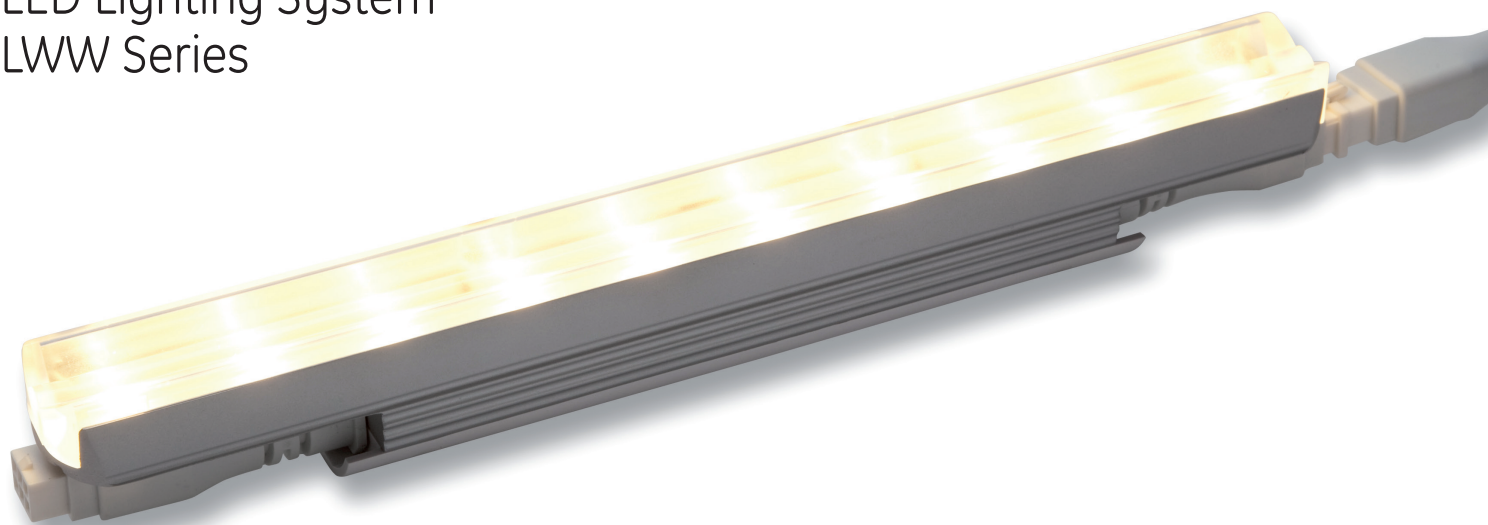

imagination at work

Product Features

GE LED Wall Washer provides uniform light and draws attention to a large area & emphasizes textures on vertical surfaces.

Uniformly light vertical surfaces and hides imperfections on flat surfaces. These fixtures are typically mounted in a recess a few feet from the wall.

Features & Benefits

- Precise use of light output and eliminates socket shadows that is common when using fluorescent fixtures
- 0-10V dimmable (as low as 3%)
- Consistent color with 3-step MacAdam ellipse color binning
- Available in a variety of optics to optimize architectural designs
- IP51, dry or damp location rated

Easy Installation

- Field-adjustable mounting for precise fixture angle
- Connect up to 300 fixtures in series
- Universal 120-277 VAC input design

LED Technology

- L85 at 50,000 hours
- 5 year limited warranty
- No UV emissions



Mounting Methods

Fixture mounting positions:

It is recommended that the LED fixtures be installed into a space no smaller than 3 in. x 3 in. (76mm x 76mm)

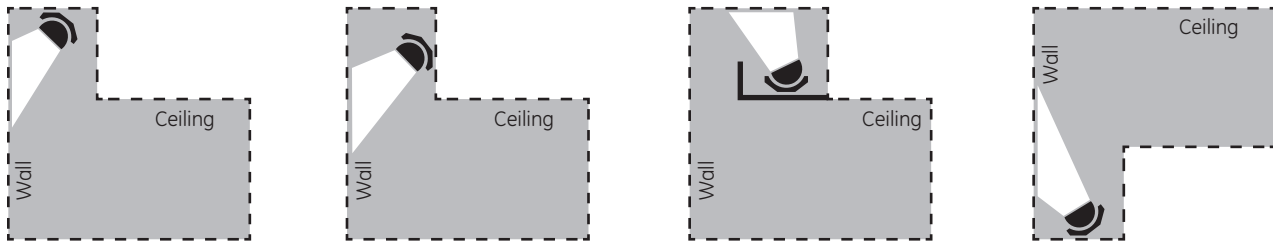

Fixture rotation:

Light can be directed from 0 to 50 degrees in 10 degree increments in both directions with the help of 1) the rotation angle of the fixture, and 2) the mounting edge of the fixture track.

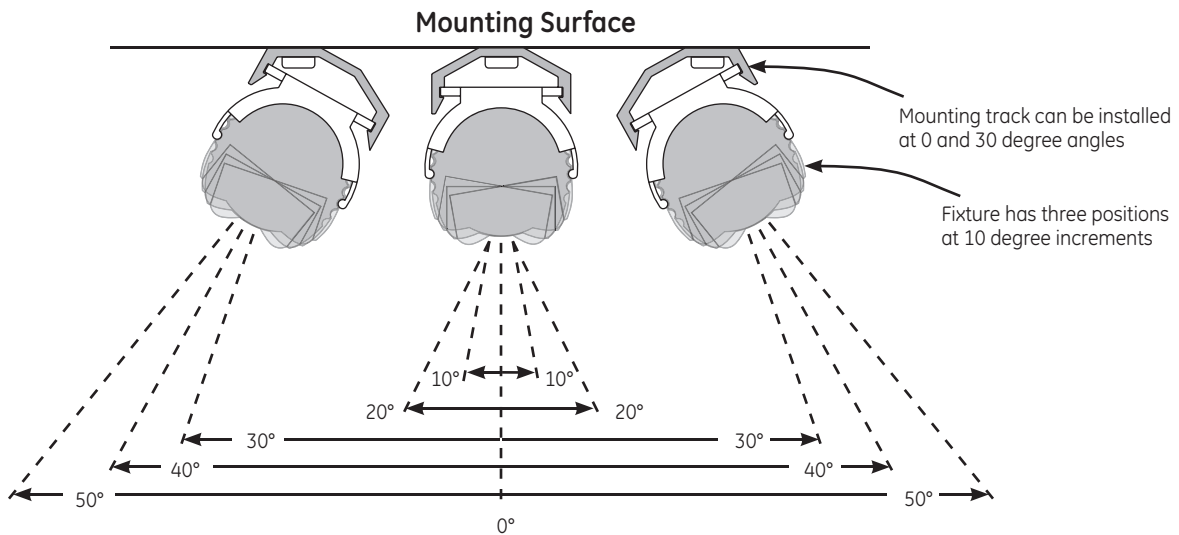

SKU Logic

Example - LWW1-MO12-110-840

(12"4000K Linear Wall Washer, Medium Output with wide beam)

Internal GE Code	Generation	Output	Length	Lens Viewing Angle	CRI	CCT
LWW	1	MO	12	110	8	40
L - Linear W - Wall W- Washer	1 - 1st	MO - Medium HO - High	12"	(012) - 12 x 80 (030) - 30 x 80 (110) - 100 x 100	8-80	27 - 2700°K 30 - 3000°K 40 - 4000°K

For material estimations, take the length of the run in feet divided by 1.05 feet to get the quantity of fixtures needed. Take the run in feet divided by 4 feet to get the quantity of mounting tracks needed.

Photometrics

Data based on 2700K SKU

Additional IES files are available on www.gelighting.com

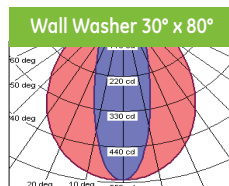

Candela (Cd) Measurements						
	100° x 100°		30° x 80°		12° x 80°	
	V	H	V	H	V	H
0°	225	225	542	542	1124	1124
10°	224	221	383	519	350	1101
20°	215	210	193	460	113	1005
30°	199	189	109	371	35	816
40°	169	159	63	268	21	568
50°	114	121	40	171	16	326
60°	55	84	30	97	13	150
70°	19	48	22	48	13	56
80°	9	22	17	17	8	16
90°	4	6	15	2	5	4

	Vertical & Horizontal Beam Width (in m)					
	100° x 100°		30° x 80°		12° x 80°	
	V	H	V	H	V	H
0.5 ft. (0.15 m)	0.4	0.4	0.1	0.3	0.0	0.3
1.0 ft. (0.30 m)	0.7	0.8	0.2	0.6	0.1	0.5
1.5 ft. (0.46 m)	1.1	1.2	0.3	0.9	0.1	0.8
2.0 ft. (0.61 m)	1.5	1.6	0.3	1.1	0.1	1.0
2.5 ft. (0.76 m)	1.8	2.0	0.4	1.4	0.2	1.3
3.0 ft. (0.91 m)	2.2	2.4	0.5	1.7	0.2	1.5

	Center Beam Illuminance (in lx)		
	100° x 100°	30° x 80°	12° x 80°
10000	24089	49956	
2500	6022	12489	
1063	2561	5312	
605	1457	3021	
390	938	1946	
272	655	1357	

Fixtures

Application	Product Code	Description Code	CCT	+/- CCT	Lens Type	Lumens per Fixture (ft/m)Min	Min LPW	Maximum Run Length
Wall Washer	62206	LWW1-MO12-030-827	2700K	+90/-55	30° x 80°	300 (286/938)	55	For 120 VAC: 140 Fixtures (~147 feet/44.82m)
Wal Washer	65447	LWW1-MO12-030-830	3000K	+123/-52	30° x 80°	320 (305/1000)	58	For 240 VAC: 290 Fixtures (~304.5 feet/92.84m)
Wall Washer	62207	LWW1-MO12-030-840	4000K	+104/-170	30° x 80°	320 (305/1000)	58	For 277 VAC: 300 Fixtures (~315 feet/96.04m)
Wall Washer	62202	LWW1-HO12-030-827	2700K	+90/-55	30° x 80°	601 (572/1876)	56	For 120 VAC: 70 Fixtures (~73.5 feet/22.41m)
Wall Washer	65445	LWW1-HO12-030-830	3000K	+123/-52	30° x 80°	641 (610/2001)	59	For 240 VAC: 140 Fixtures (~147 feet/44.82m)
Wall Washer	62203	LWW1-HO12-030-840	4000K	+104/-170	30° x 80°	641 (610/2001)	59	For 277 VAC: 165 Fixtures (~173.3 feet/52.84m)

Technical Specifications

Input Voltage: 120/240/277VAC 50/60Hz

Ambient Temperature: -20° C to 50° C

Environmental Rating: IP51, dry or damp location rated

Dimming: Compatible with many 0-10V dimmers

Min CRI: 80

Fixture Weight: 0.97 lb (0.44 kg)

Limited Warranty: 5 years

Wattage: MO fixture 5.5 W/fixture (5.2 W/ft, 17.1 W/m)

HO fixture 10.8 W/fixture (10.3 W/ft, 33.8 W/m)

System Certifications:



Components

Product Code	Description Code	Product Description	Quantity
62208	LWW1-LC1-120	120" (3048mm) Leader Cable (UL)	1/PK
62209	LWW1-JC1-12	12" (305mm) Jumper Cable	1/PK
62210	LWW1-JC1-48	48" (1219mm) Jumper Cable	1/PK
65467	LWW1-MT48/0	48" (1219mm) Mounting Track	10/PK

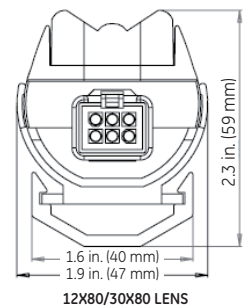
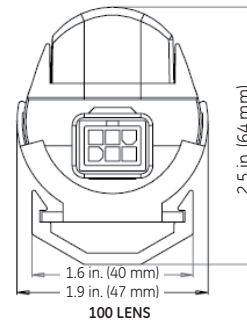

Dimensional Drawings

12X80/30X80 LENS
Fixture without track

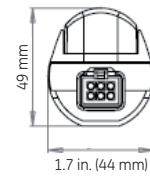
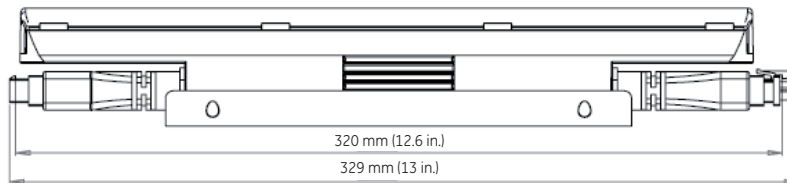
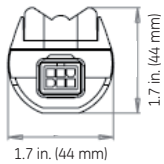

100 LENS
Fixture without track

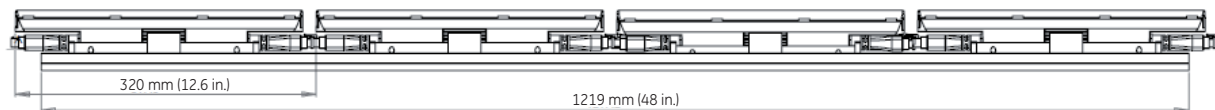

This product is intended solely for the use of non-residential architecture lighting and is not intended for any other applications.



GE Lighting • 1-888-MY-GE-LED (1-888-69-43-533) • www.gelighting.com

GE Lighting Solutions, LLC is a subsidiary of the General Electric Company. Tetra is a trademark of GE Lighting. The GE brand and logo are trademarks of the General Electric Company. © 2013 GE Lighting Solutions, LLC. Information provided is subject to change without notice. All values are design or typical values when measured under laboratory conditions.