

# Tetra<sup>®</sup> Contour

## LED Lighting System

GEXNBL-1, GEXNGL-1, GEXNYG-1, GEXNRC-1, GEXNRD-1, GEXN65-1, GEXN32-1

Installation Guide

24  
Volt



### BEFORE YOU BEGIN

Read these instructions completely and carefully.

#### ⚠ WARNING/AVERTISSEMENT

##### RISK OF ELECTRIC SHOCK

- Disconnect power at fuse box or circuit breaker before servicing or installing product.
- Properly ground Tetra<sup>®</sup> power supply.

##### RISK OF FIRE

- Use only Tetra<sup>®</sup> supply wire to make connection from Tetra<sup>®</sup> power supply to Tetra<sup>®</sup> LED strip.
- Use only approved wire for input/output connection. Minimum size 18 AWG (0.82mm<sup>2</sup>)
- Follow all local codes.
- Waterproof wire connection for outdoor or wet installations. See instructions for details.
- Do not stretch light engines.
- Inspect and replace the light engines if any tear or damage affects their integrity.
- Avoid installation that leads to prolonged exposure to standing water or ice.

##### RISK OF FIRE OR ELECTRIC SHOCK

- LED Retrofit Kit installation requires knowledge of sign electrical systems. If not qualified, do not attempt installation. Contact a qualified electrician.
- Install this kit only in host signs that have been identified in the installation instructions and where the input rating of the retrofit kit does not exceed the input rating of the sign.
- Installation of this LED retrofit kit may involve drilling or punching of holes into the structure of the sign. Check for enclosed wiring and components to avoid damage to wiring and electrical parts.
- Do not make or alter any open holes in an enclosure of wiring or electrical components during kit installation.

##### RISQUES DE CHOC ÉLECTRIQUE

- Coupez l'alimentation électrique à la boîte de fusibles ou au disjoncteur avant l'entretien ou l'installation du produit.
- Assurez-vous de correctement mettre à terre l'alimentation électrique Tetra<sup>®</sup>.

##### RISQUES D'INCENDIE

- N'utilisez que le fil d'approvisionnement Tetra<sup>®</sup> pour faire la connexion entre l'alimentation Tetra<sup>®</sup> et la bande DEL Tetra<sup>®</sup>.
- N'utilisez que des fils approuvés pour les entrées/sorties de connexion. Taille minimum 18 AWG (0.82mm<sup>2</sup>).
- Respectez tous les codes locaux.
- Étanchéfier les connexions électriques effectuées à l'extérieur ou pour un environnement exposé à l'eau. Voir les instructions d'installation pour plus de détails.
- Ne pas étirer les modules DEL Contour.
- Inspecter l'intégrité des modules DEL Contour et les remplacer s'ils sont déchirés ou endommagés.
- Éviter les installations avec une exposition prolongée à l'eau stagnante ou à la glace.

##### RISQUE D'INCENDIE OU DE CHOC ÉLECTRIQUE

- L'installation de l'équipement de remplacement DEL exige la connaissance des systèmes électriques pour enseignes. Si non qualifié, ne tentez pas d'installation. Veuillez contacter un électricien qualifié
- Risque d'incendie ou de choc électrique. Installez cet ensemble seulement dans des enseignes hôtes qui ont été identifiés dans les instructions d'installation et dont la capacité d'entrée de l'ensemble ne dépasse pas la capacité d'entrée de l'enseigne.
- L'installation de cet équipement de remplacement DEL peut impliquer le perçage ou le poinçonnage de trous dans la structure du panneau. Vérifiez le câblage et les composants inclus pour éviter d'endommager le câblage et les composants électriques.
- Ne pas faire ou modifier les trous ouverts dans une enceinte de câblage ou de composants électriques pendant l'installation de cet équipement de remplacement DEL.

### Save These Instructions

Use only in the manner intended by the manufacturer. If you have any questions, contact the manufacturer.



RETROFIT SIGN CONVERSION LED KIT FOR USE ONLY IN ACCORDANCE WITH KIT INSTRUCTIONS.

KIT IS COMPLETE ONLY WHEN ALL PARTS REQUIRED BY THE INSTRUCTIONS ARE PRESENT.

TROUSSE DE CONVERSION À DEL POUR LA MODERNISATION DES ENSEIGNES

À UTILISER CONFORMÉMENT AU GUIDE D'INSTALLATION.

This device complies with part 15 of the FCC Rules. Operation is subject to the following two conditions: (1) This device may not cause harmful interference, and (2) this device must accept any interference received, including interference that may cause undesired operation. CAN ICES-005 (A) / NMB-005 (A)

Note: This equipment has been tested and found to comply with the limits for a Class A digital device, pursuant to part 15 of the FCC Rules. These limits are designed to provide reasonable protection against harmful interference when the equipment is operated in a commercial environment. This equipment generates, uses, and can radiate radio frequency energy and, if not installed and used in accordance with the instruction manual, may cause harmful interference to radio communications. Operation of this equipment in a residential area is likely to cause harmful interference in which case the user will be required to correct the interference at his own expense.

current  
powered by GE



## Prepare Electrical Wiring



### Electrical Requirements

- Light engines without light guide limited to indoor dry locations.
- Light engines with light guide acceptable to use in dry, damp or wet locations when installed correctly.
- The grounding and bonding of the LED Driver shall be done in accordance with National Electric Code (NEC) Article 600.
- Follow all National Electric Codes (NEC) and local codes.
- These products are only suitable for connection to a circuit from a Class 2 power source. These products have not been evaluated for use when connected to a power source that does not comply with Class 2 voltage and energy limited supplies.

## Components and Tools Required

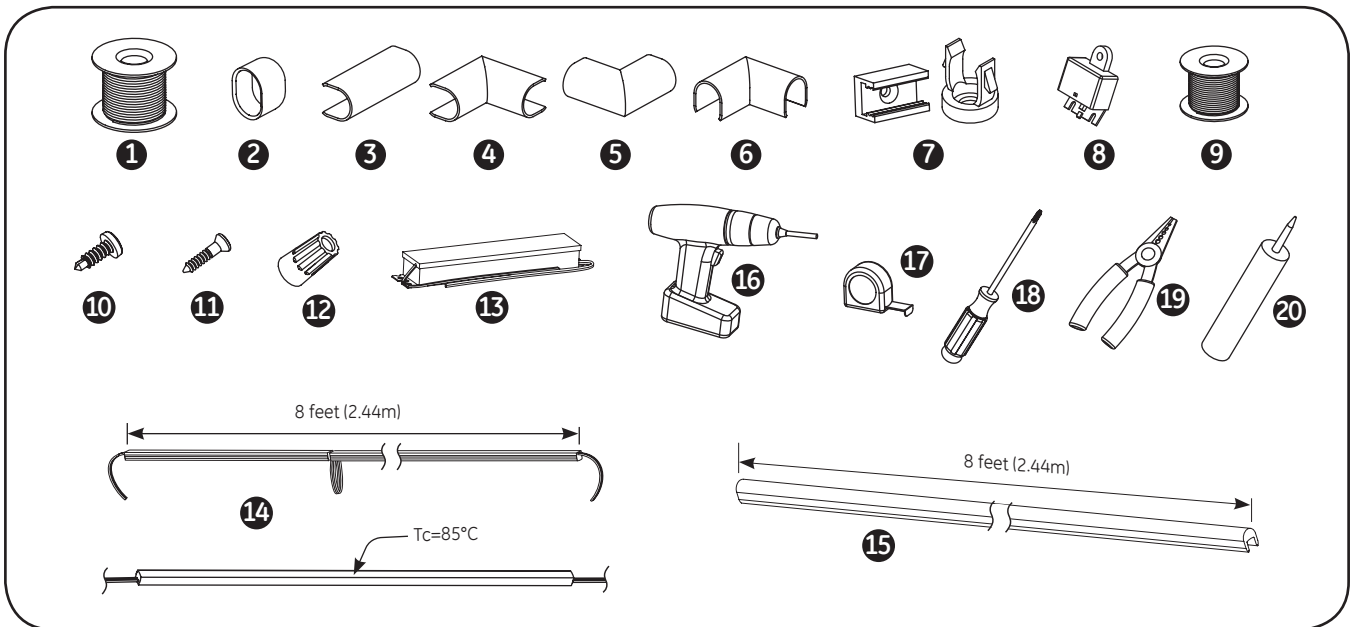

- 1 UL approved 18 AWG (0.82mm<sup>2</sup>) supply wire
- 2 Tetra® End Caps
- 3 Tetra® Contour Light Guide connector
- 4 Tetra® Contour Light Guide 90° inside corner
- 5 Tetra® Contour Light Guide 90° outside corner
- 6 Tetra® Contour Light Guide 90° planar corner
- 7 Tetra® mounting clips
- 8 Weather box GEXNWB2
- 9 22 AWG (0.33mm<sup>2</sup>) tie-wire
- 10 #6, #8 or #10 (M2, M3 or M4) self drilling pan headed screws
- 11 #6 (M2) screws
- 12 UL approved 22-14 AWG (0.33-2.08mm<sup>2</sup>) twist-on wire connectors
- 13 Tetra® 24 Volt power supply
- 14 Tetra® Contour Light Engine
- 15 Tetra® Contour Light Guide
- 16 Cordless drill

- 17 Tape measure
- 18 Screwdriver
- 19 Wire stripper/cutter
- 20 Electrical grade silicone

### Examples of electrical grade silicone:

- Momentive RTV 6700 Series Silicone Rubber Adhesive Sealant
- Momentive White Blanc RTV 162 Silicone Rubber Adhesive Sealant-Electrical Grade
- Dow Corning 3140 - Non-Corrosive Flowable (clear)
- Dow Corning 3145 - Non-Corrosive Nonflowable (clear or gray)
- Dow Corning RTV 748 Non-Corrosive Sealant-White

### 21 Cutting Resolution Table

Light Engine Color	Cutting Resolution
Red	2.29 in. (58 mm)
Red-orange	2.29 in. (58 mm)
Amber	2.29 in. (58 mm)
Green	2.29 in. (58 mm)
Blue	2.29 in. (58 mm)
White	2.00 in. (51 mm)
Warm White	2.00 in. (51 mm)

## METHOD A - Installing Light Engines With Light Guides

### Planning First

Plan the layout by measuring the design layout and dividing by 8 ft. (2.44m) to determine the required quantity of Tetra Contour. Refer to the *Cutting Resolution Table* on page 2 when cutting any Tetra Contour section.

Do not use more than one suffix code for each respective application, as mixing suffix codes may result in appearance variation. Suffix code can be found on the packaging label

Installation methods shown are for straight runs. For custom shapes, refer to the Light Guide Forming Instructions. If you have any questions about these instructions or your specific Contour application, please contact support at tetra.support@ge.com.

Mounting orientation if moisture may accumulate inside light guide.

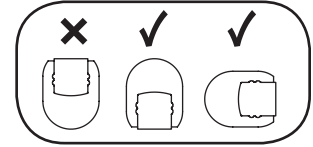

### Installation

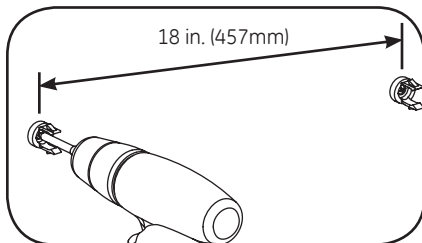

- 1** Install a minimum of one clip per 18 in. (457mm) using #10 (M4) screws.

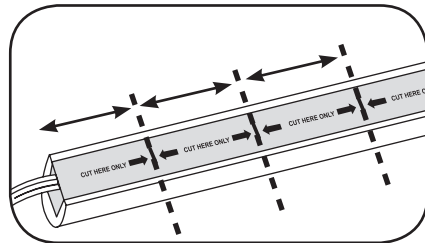

- 2** Using the light guide final length, measure out the necessary length of Contour LED light engine to match. If required, using a sharp cutting tool, cut wire loops between sections or through light engine (refer to the *Cutting Resolution Table* on page 2).

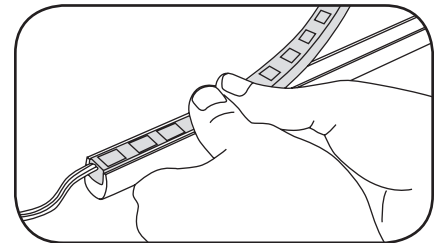

- 3** Push the light engine segments down into the light guide.

#### **⚠️ WARNING/AVERTISSEMENT**

**RISK OF FIRE:** The light engine is not intended for excessive or repetitive bending or stretching. If the silicone does crack, replace the light engine.

**RISQUE D'INCENDIE:** Les modules DEL Contour ne sont pas conçus pour des pliages excessifs, répétitifs ou pour être étirés. Si le silicone montre des signes de craquement, remplacer le module DEL Contour.

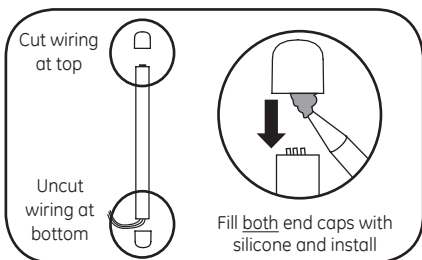

- 4** For vertical or near vertical installations, any cut-end termination of a Contour piece shall reside at the top of the design.

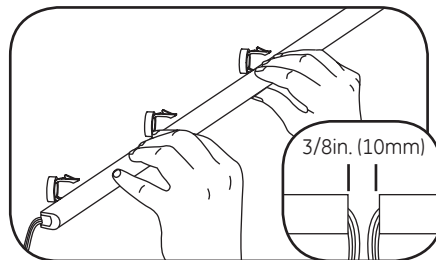

- 5** Attach Tetra Contour to the mounting clips, leaving a 3/8 in. (10mm) gap between sections to allow for expansion or contraction.

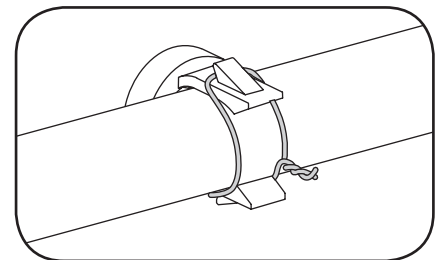

- 6** Secure light guide by twisting tie-wire around the mounting clip and light guide.

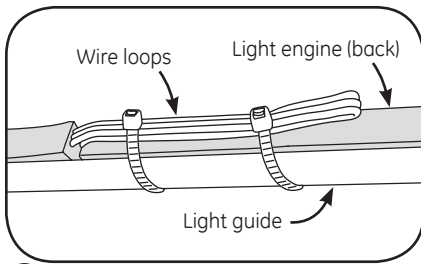

**7** Wires between light guide segments can be folded behind the light guide and attached with clear zip ties. Zip ties should wrap around outside light guide.

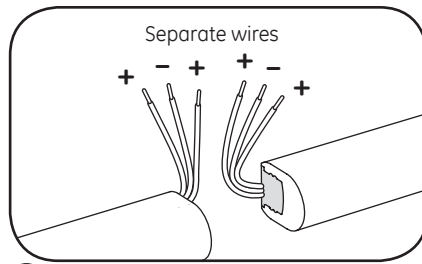

**8** To connect two light engines separate wires and identify outer conductors as positive (+) and middle conductors as negative (-). Strip ends back 0.5 in. (13mm).

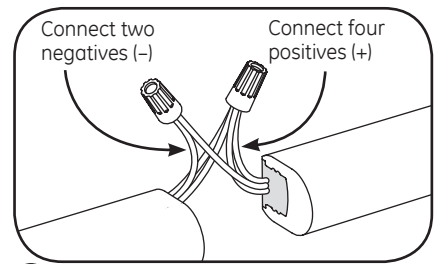

**9** Use twist-on wire connectors to join wires together.

### ⚠ WARNING/AVERTISSEMENT

**RISK OF FIRE:** Waterproof wire connection and all cut ends for outdoor or wet installations. Weather box is required for all outdoor or wet locations electrical connections. / **RISQUE D'INCENDIE:** Étanchéifier les connexions électriques et sceller l'extrémité des sections coupées effectuées à l'extérieur ou pour un environnement exposé à l'eau. Un boîtier étanche est requis pour les connexions électriques effectuées à l'extérieur ou dans un environnement avec exposition à l'eau.

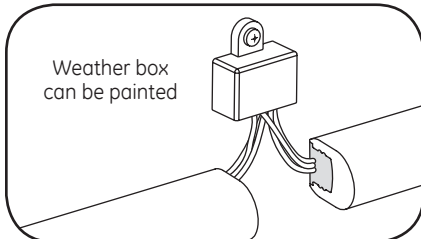

**10** Insert wire connectors into weather box. Fill with electrical grade silicone and close box. Weather box can be mounted using #8 (M3) screws.

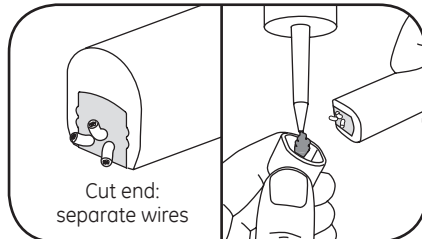

**11** For cut end, manually untwist and separate wires to avoid shorts. Fill cap with electrical grade silicone and push cap on the end to seal. Clean excess silicone.

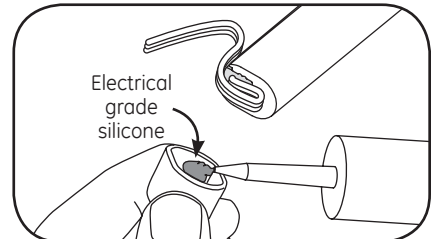

**12** For uncut end, fold wire over Tetra Contour. Fill the end cap with silicone and push cap on the end to secure. Clean excess silicone.

## Joining with Light Guide Connectors, Corners and Bends

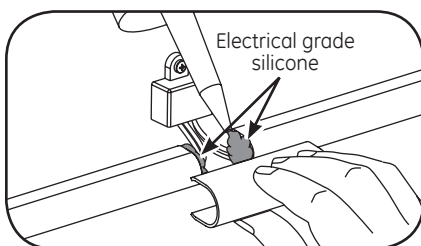

**13** Linear: At each gap between sections, apply silicone on both sides to secure light guide connector. Snap on a light guide connector.

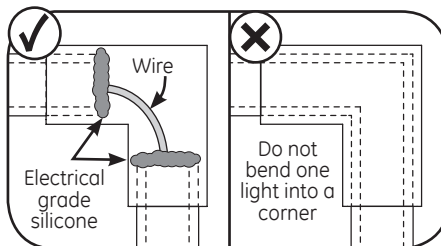

**14** Corner: For all corners (planar, inside, outside) apply silicone on both sides to secure light guide corners. Snap on corner. Follow Steps 8-10 if wires are cut.

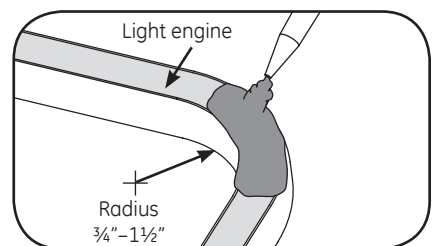

**15** Bends having an inside radius 1 1/2" or smaller must have electrical grade silicone applied directly to the light engine across the bend.

### ⚠ WARNING/AVERTISSEMENT

**RISK OF FIRE:** DO NOT bend the light engine to an inside radius that is tighter than 3/4 in. (19mm). / **RISQUE D'INCENDIE:** Ne pas plier les modules DEL Contour avec un rayon de courbure inférieur à 3/4 pouce (19 mm).

## Connect Power Supply

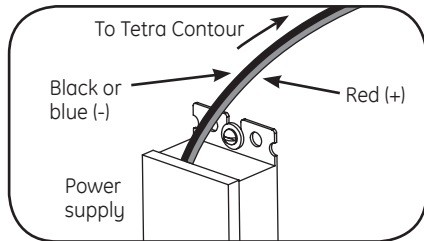

- 16** Run a wire from the power supply to a section of Tetra Contour. Power supply connection must be completed in an acceptable UL/ NEMA enclosure. Power supply loading is described in the power supply installation instructions.

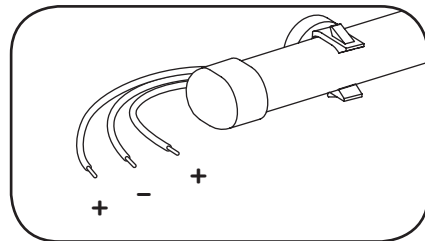

- 17** Separate wires and identify outer conductors as positive (+) and middle conductor as negative (-). Strip ends back 0.5 in. (13mm).

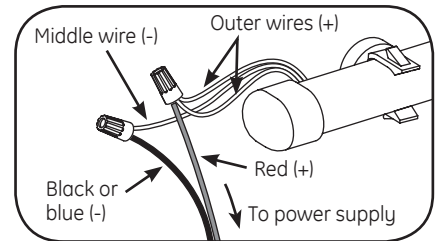

- 18** Connect the two outer wires (+) from the LED strip to the red wire (+) of the power supply. Connect the middle wire (-) from the LED strip to the black or blue wire (-) of the power supply. Grounding and bonding must be done in accordance with National Electrical Code (Article 600). See power supply instructions.

### **⚠ WARNING/AVERTISSEMENT**

**RISK OF ELECTRICAL SHOCK:** Turn power OFF before inspection, installation or removal. / **RISQUES DE CHOC ÉLECTRIQUE:** Coupez l'alimentation électrique avant d'inspecter, d'installer ou de déplacer le luminaire.

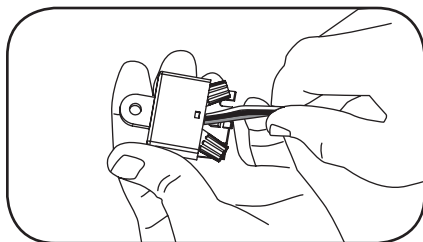

- 19** Insert wire connectors into weather box. Fill with electrical grade silicone and close box.

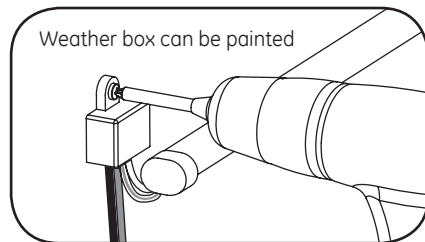

- 20** Secure the weather box using a #6 or #8 (M2 or M3) screw.

## METHOD B - Installing Light Engines Without Light Guides (Dry Indoor Only)

### **⚠ WARNING/AVERTISSEMENT**

**RISK OF FIRE:** Light engine by itself is intended for use in dry indoor application only.  
**RISQUES DE D'INCENDIE:** Les modules DEL Contour utilisés seuls sont conçus pour les environnements intérieurs secs seulement.

## Planning First

Plan the layout by measuring the design layout and dividing by 8 ft. (2.44m) to determine the required quantity of Tetra Contour. Refer to the *Cutting Resolution Table* on page 2 when cutting any Tetra Contour section.

Do not use more than one suffix code for each respective application, as mixing suffix codes may result in appearance variation. Suffix code can be found on the packaging label.

Installation methods shown are for straight runs. For custom shapes, install mounting clips at regular intervals throughout the shape to provide adequate support for the light engine.

**DO NOT** bend the light engine to an inside radius that is tighter than 3/4 in. (19mm). The light engine is not intended for excessive or repetitive bending or stretching. If the silicone does crack, electrical grade silicone can be applied to seal the crack.

If you have any questions about these instructions or your specific Contour application, please contact support at [tetra.support@ge.com](mailto:tetra.support@ge.com).

## Installation

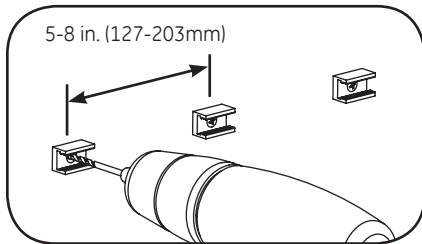

**1** Install a mounting clip, using #6 (M2) counter sink screws, every 5–8 inches (127–203mm) on center until the end of the run is reached.

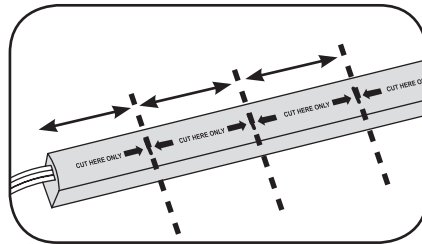

**2** Using the light engine final length, measure out the necessary length of Contour light engine. If required, using a **sharp** cutting tool, cut wire loops between sections or through light engine.

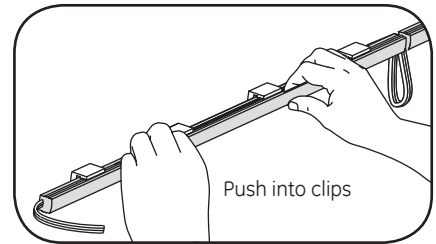

**3** Push each 16 in. (406mm) light engine segment into the clips. Fold loose wires behind light engines. Do not stretch light engines.

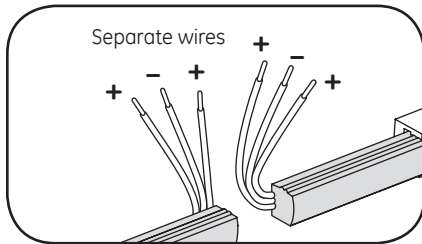

**4** Separate wires and identify outer conductors as positive (+) and middle conductors as negative (-). Strip ends back 0.5 in. (13mm).

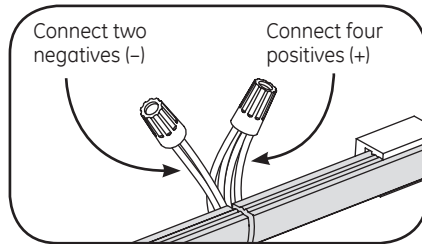

**5** Use twist-on wire connectors to join cut wires together. Fold wires behind light engines.

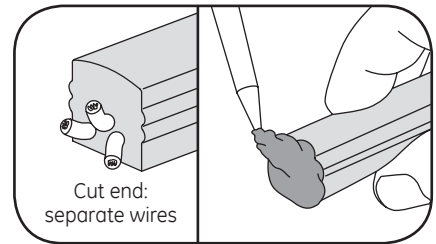

**6** For cut end, manually untwist and separate wires to avoid shorts. Seal light engine end with electrical grade silicone. Clean excess silicone.

## Connect Power Supply

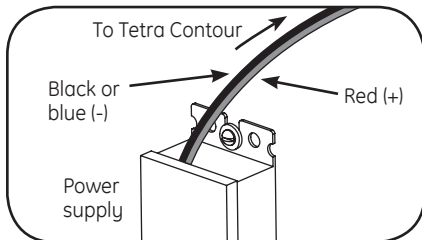

**7** Run a wire from the power supply to a section of Tetra Contour. Power supply connection must be completed in an acceptable UL/ NEMA enclosure. Power supply loading is described in the power supply installation instructions.

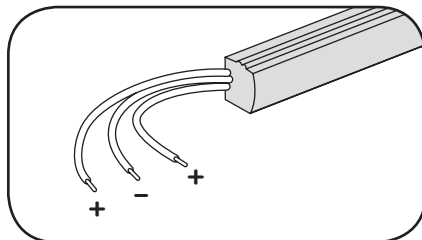

**8** Separate wires and identify outer conductors as positive (+) and middle conductor as negative (-). Strip ends back 0.5 in. (13mm).

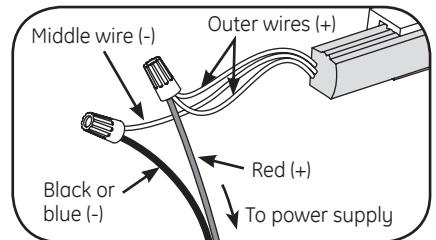

**9** Connect the two outer wires (+) from the LED strip to the red wire (+) of the power supply. Connect the middle wire (-) from the LED strip to the black or blue wire (-) of the power supply. Grounding and bonding must be done in accordance with National Electrical Code (Article 600). See power supply instructions.

### **⚠ WARNING/AVERTISSEMENT**

**RISK OF ELECTRICAL SHOCK:** Turn power OFF before inspection, installation or removal. / **RISQUES DE CHOC ÉLECTRIQUE:** Coupez l'alimentation électrique avant d'inspecter, d'installer ou de déplacer le luminaire.



## METHOD C - Attaching Tetra Contour LS to Tetra Contour

### ⚠ WARNING/AVERTISSEMENT

**RISK OF FIRE:** Waterproof wire connection for outdoor or wet installations. Weather box is required for all outdoor or wet locations electrical connections. / **RISQUE D'INCENDIE:** Étanchéfier les connexions électriques effectuées à l'extérieur ou pour un environnement exposé à l'eau. Un boîtier étanche est requis pour les connexions électriques effectuées à l'extérieur ou dans un environnement avec exposition à l'eau.

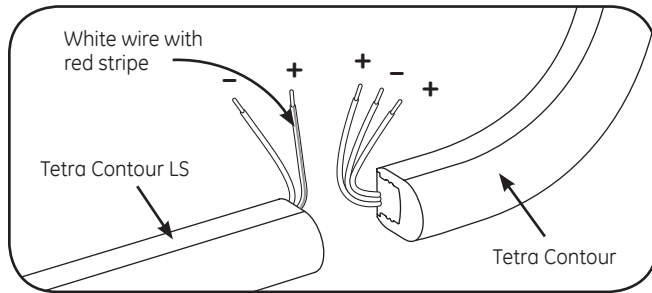

- 1 Tetra Contour LS can be connected to formable Tetra Contour for custom shapes. Separate wires and identify conductors as positive (+) and negative (-). Strip ends back 0.5 in. (13mm).

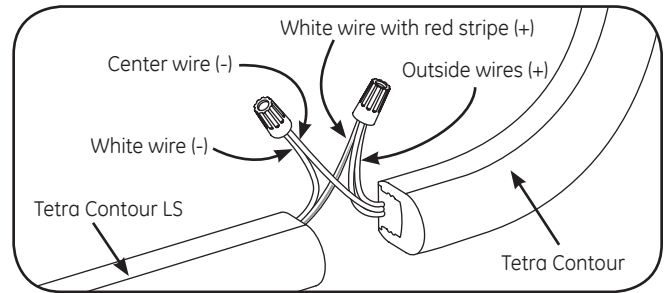

- 2 Splice the white wire with red stripe (+) of Tetra Contour LS to the two outside wires (+) of Tetra Contour and splice the white wire (-) of Tetra Contour LS to the center wire (-) of Tetra Contour.

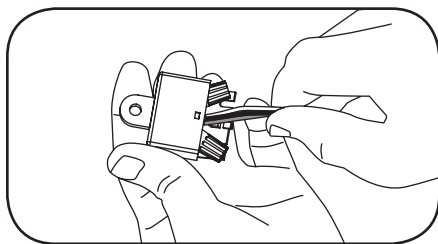

- 3 Insert wire connectors into weather box. Fill with electrical grade silicone and close box.

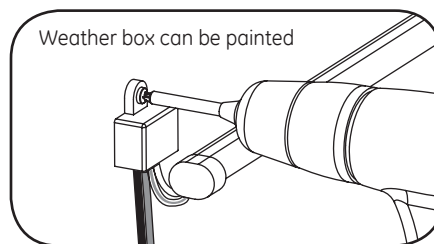

- 4 Secure the weather box using a #6 or #8 (M2 or M3) screw. When using twist-on connectors, weather box is required for all outdoor electrical connections.

**NOTE:** For assembling accessories like connectors and corners, see Page 4.

If you have any questions about these instructions or your specific Contour application, please contact support at [tetra.support@ge.com](mailto:tetra.support@ge.com).

## Additional Instructions for Retrofit

1. **(Existing Signs Only)** Prior to installation, survey the site for information regarding power and accessibility inside and outside the building. Ensure that the branch circuit supplying the existing transformer or ballast will be within the voltage ratings of the new LED power supply, and have a current rating not exceeding 20A, or that permitted by applicable local, state, or country electrical codes (whichever is less).
2. **(Existing Signs Only)** Remove the existing lighting equipment to be replaced, such as neon tubing or fluorescent tubes; and associated transformers and ballasts. Care should be taken not to break the existing neon or fluorescent tubes.  
**NOTE:** Follow all federal and local regulations when disposing of neon tubing, fluorescent tubes, transformers and ballasts.
3. **(Existing Signs Only)** If removal of the existing lighting equipment eliminates the disconnect switch, as required by applicable local, state, or country electrical codes; a new disconnect switch must be installed.
4. **(Existing Signs Only)** Repair and seal any unused openings in the electrical enclosure. Openings greater than 12.7-mm (1/2-in) diameter require a metal patch secured by screws or rivets and caulked with non-hardening caulk. Smaller openings may be sealed with non-hardening caulk.
5. Using the layout guidelines above, determine required number of LED modules required to illuminate the sign.
6. A Tetra® 24VDC Class 2 Power Supply, as listed below, must be used with this retrofit kit. Determine the number of Tetra® Class 2 Power Supplies required to power the number of LED modules required to illuminate the sign, so as not to overload the Tetra® Class 2 Power Supply chosen.
7. Follow Method A, B or C to mount the Tetra Contour.
8. Connect the DC output of the power supply to the LED modules using the Electrical Connections instructions above.
9. Connect the power unit to the supply in accordance with the applicable local, state, and country electrical codes, and the instructions found in the power supply installation guide.
10. If required, the disconnect switch shall be installed by qualified personnel, in accordance with applicable local, state, and country electrical codes.

## Troubleshooting

Symptom	Condition	Solution
All LEDs are OFF	No AC input.	Attach AC input and/or check circuit breaker.
	Incorrect wire attachment.	Check wire connection(s) at the Tetra Contour LED light engine and power supply for improper connections or short circuits. Make sure you have positive to positive and negative to negative wire connections.
Some LEDs appear dim	Overload (maximum load exceeded).	Ensure the overall length of Tetra Contour LED light engine does not exceed the maximum load as detailed in the <b>Tetra Power Supply Installation Instructions</b> .
	Maximum recommended supply wire length exceeded.	Reduce the length of supply wire equal to or below the recommended maximum.
	Mixed Suffix Codes of LED light engine within an application.	Make sure that all LED light engines have the same Suffix Code (Suffix Code is located on each packaging label).
Some of the sections are not illuminated	Incorrect wire attachment.	Check the wire connections at the Tetra Contour LED light engine for improper connections. Make sure you have positive to positive and negative to negative wire connections. Check for improper cutting resolution locations (see Item 21 on Page 2).
Light/dark banding along a section	LED light engine stretched during installation.	Remove LED light engine and properly install. Inspect and replace light engine if the silicone is damaged.

## Specifications

### Maximum Loading per Tetra® 24 VDC Power Supply

SKU	Rating	25W	80W	100W	180W	300W
		Power Supply <i>Note: Load shall not exceed 0.83A</i>	Power Supply <i>Note: Load shall not exceed 3.3A</i>	Power Supply <i>Note: Load shall not exceed 4A</i>	Power Supply <i>Note: Load shall not exceed 3.8A per each (of 2) output channels</i>	Power Supply <i>Note: Load shall not exceed 4A per each (of 3) output channels</i>
GEXNRD-1, GEXNBL-1, GEXNGL-1	24VDC, 1.52W/ft. (Strip) 1.79W/ft. (System)	14ft. (4.27 m)	50 ft. (15.24 m)	59 ft. (17.9 m)	55 ft. (16.76 m) per output channel 110 ft. (33.53 m) per power supply	59 ft. (17.9 m) per output channel 177 ft. (53.9 m) per power supply
GEXNYG-1, GEXNRC-1	24VDC, 2.27W/ft. (Strip) 2.67W/ft. (System)	8 ft. (2.44 m)	33 ft. (10.06 m)	40 ft. (12.19 m)	37 ft. (11.28 m) per output channel 74 ft. (22.55 m) per power supply	40 ft. (12.1 m) per output channel 120 ft. (36.5 m) per power supply
GEXN65-1, GEXN32-1	24VDC, 3.17W/ft. (Strip) 3.73W/ft. (System)	6 ft. (1.83 m)	24 ft. (7.3 m)	29 ft. (8.8 m)	27 ft. (8.2 m) per output channel 54 ft. (16.4 m) per power supply	29 ft. (8.8 m) per output channel 87 ft. (26.5 m) per power supply

### Maximum Remote Mounting Distance

	18 AWG/0.82 mm <sup>2</sup> Supply Wire	16 AWG/1.31 mm <sup>2</sup> Supply Wire	14 AWG/2.08 mm <sup>2</sup> Supply Wire	12 AWG/3.31 mm <sup>2</sup> Supply Wire
25W Power Supply	20 ft./6.1 m	-	-	-
80W Power Supply	20 ft./6.1 m	30 ft./9.1 m	50 ft./15.2 m	86 ft./26.1 m
100W Power Supply	20 ft./6.1 m	30 ft./9.1 m	50 ft./15.2 m	86 ft./26.1 m
180W Power Supply	20 ft./6.1 m	30 ft./9.1 m	50 ft./15.2 m	86 ft./26.1 m

This product is intended solely for the use of non-residential signage lighting and is not intended for use in any other applications.

Conforms to the following standards:



**current**  
powered by GE

All trademarks are the property of their respective owners. Information provided is subject to change without notice. All values are design or typical values when measured under laboratory conditions. Current, powered by GE is a business of the General Electric Company.  
© 2019 GE.

