

# Tetra<sup>®</sup> PowerStrip

## LED Lighting System

Installation Guide

24  
Volt

(GESS2471-2, GESS2450-2, GESS2441-2, GESS2432-2, GESS24H71-2, GESS24H50-2, GESS24H41-2, GESS24H32-2)



### BEFORE YOU BEGIN

Read these instructions completely and carefully.

#### ⚠ WARNING/AVERTISSEMENT

##### RISK OF ELECTRIC SHOCK

- Turn power off before inspection, installation or removal.
- Properly ground GE power supply enclosure.

##### RISK OF FIRE

- Use only UL approved wire for input/output connections. Minimum size 18 AWG (0.82mm<sup>2</sup>)
- Follow all NEC and local codes.
- Not to be submerged or used in a marine environment.

##### RISK OF FIRE OR ELECTRIC SHOCK

- LED Retrofit Kit installation requires knowledge of sign electrical systems. If not qualified, do not attempt installation. Contact a qualified electrician.
- Install this kit only in host signs that have been identified in the installation instructions and where the input rating of the retrofit kit does not exceed the input rating of the sign.
- Installation of this LED retrofit kit may involve drilling or punching of holes into the structure of the sign. Check for enclosed wiring and components to avoid damage to wiring and electrical parts.
- Do not make or alter any open holes in an enclosure of wiring or electrical components during kit installation.

##### RISQUES DE DÉCHARGES ÉLECTRIQUES

- Coupez l'alimentation avant l'inspection, l'installation ou le déplacement.
- Assurez-vous de correctement mettre à terre l'alimentation électrique GE.

##### RISQUES D'INCENDIE

- N'utilisez que des fils approuvés par UL pour les entrées/sorties de connexion. Taille minimum 18 AWG (0.82mm<sup>2</sup>)
- Respectez tous les codes NEC et codes locaux.
- Ne pas submerger ou installer dans un environnement marin.

##### RISQUE D'INCENDIE OU DE CHOC ÉLECTRIQUE

- L'installation de l'équipement de remplacement DEL exige la connaissance des systèmes électriques pour enseignes. Si non qualifié, ne tentez pas d'installation. Veuillez contacter un électricien qualifié.
- Risque d'incendie ou de choc électrique. Installez cet ensemble seulement dans des enseignes hôtes qui ont été identifiés dans les instructions d'installation et dont la capacité d'entrée de l'ensemble ne dépasse pas la capacité d'entrée de l'enseigne.
- L'installation de cet équipement de remplacement DEL peut impliquer le perçage ou le poinçonnage de trous dans la structure du panneau. Vérifiez le câblage et les composants inclus pour éviter d'endommager le câblage et les composants électriques.
- Ne pas faire ou modifier les trous ouverts dans une enceinte de câblage ou de composants électriques pendant l'installation de cet équipement de remplacement DEL.

#### ⚠ CAUTION/ATTENTION

##### RISK OF INJURY

- While performing installations described, gloves, safety glasses or goggles should be worn.

##### RISQUE DE BLESSURE

- Lors de l'exécution des installations décrites, des gants, des lunettes de sécurité ou des lunettes de protection doivent être portées.

### Save These Instructions

Use only in the manner intended by the manufacturer. If you have any questions, contact the manufacturer.



RETROFIT SIGN CONVERSION LED KIT FOR USE ONLY IN ACCORDANCE WITH KIT INSTRUCTIONS.

KIT IS COMPLETE ONLY WHEN ALL PARTS REQUIRED BY THE INSTRUCTIONS ARE PRESENT.

TROUSSE DE CONVERSION À DEL POUR LA MODERNISATION DES ENSEIGNES

À UTILISER CONFORMÉMENT AU GUIDE D'INSTALLATION.

### Prepare Electrical Wiring



#### Electrical Requirements

- Limited to use in dry and damp locations.
- The grounding and bonding of the LED Driver shall be done in accordance with National Electric Code (NEC) Article 600.
- Follow all National Electric Codes (NEC) and local codes.
- These products are only suitable for connection to a circuit from a Class 2 power source. These products have not been evaluated for use when connected to a power source that does not comply with Class 2 voltage and energy limited supplies.

This device complies with part 15 of the FCC Rules. Operation is subject to the following two conditions: (1) This device may not cause harmful interference, and (2) this device must accept any interference received, including interference that may cause undesired operation.

**Note:** This equipment has been tested and found to comply with the limits for a Class A digital device, pursuant to part 15 of the FCC Rules. These limits are designed to provide reasonable protection against harmful interference when the equipment is operated in a commercial environment. This equipment generates, uses, and can radiate radio frequency energy and, if not installed and used in accordance with the instruction manual, may cause harmful interference to radio communications. Operation of this equipment in a residential area is likely to cause harmful interference in which case the user will be required to correct the interference at his own expense.

This Class [A] RFLD complies with the Canadian standard ICES-005. Ce DEFR de la classe [A] est conforme à la NMB-005 du Canada.

**current**  
powered by GE



## Components

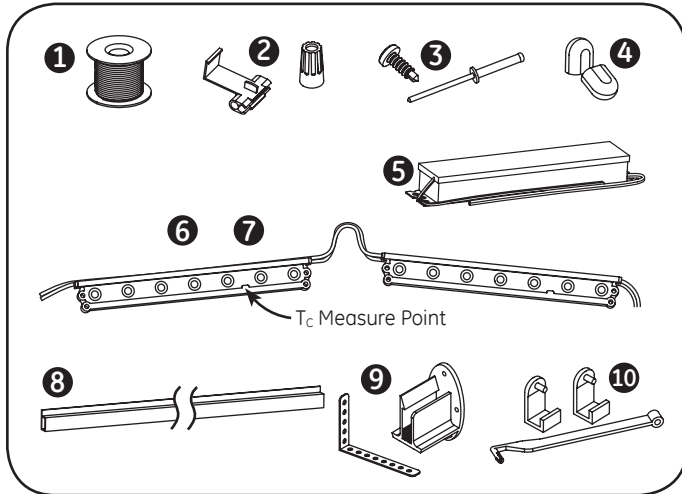

- 1 UL certified 18 AWG (0.82 mm<sup>2</sup>) supply wire
- 2 UL certified 22-14 AWG (0.33-2.08 mm<sup>2</sup>) wire connectors or 22-18 AWG (0.33-0.82 mm<sup>2</sup>) inline/IDC connectors
- 3 #6 or #8 (M3 or M4) screws, 1/8 inch (3.2mm) rivets, electronic grade silicone, or equivalent
- 4 End caps
- 5 Tetra® 24 Volt Power Supply
- 6 Tetra® PowerStrip SS MO LED modules
- 7 Tetra® PowerStrip SS High Output LED modules

### Optional

- 8 Tetra® Mounting Rail
- 9 Tetra® Assembly Bracket or Mounting Rail Clip
- 10 Tetra® Angle Mounting Clips and Extender Rod

## Layout Recommendations

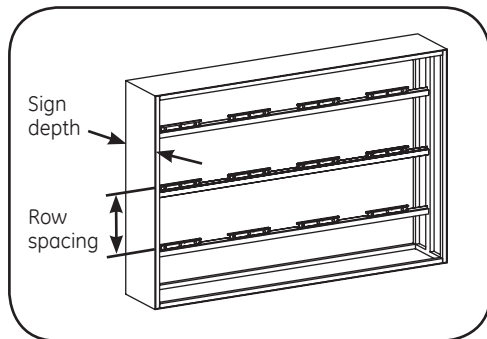

Tetra Module	Depth	Stroke Width	Mod to Mod Spacing
Single Sided PowerStrip and Single Sided Powerstrip High Output	5-6" (127-152mm)	10" (254mm)	12" (305mm)
	6-7" (152-178mm)	12" (305mm)	12" (305mm)
	7-8" (178-203mm)	13" (330mm)	12" (305mm)
	8-9" (203-229mm)	14" (356mm)	12" (305mm)
	9-10" (229-254mm)	15" (381mm)	12" (305mm)
	10-11" (254-279mm)	16" (406mm)	12" (305mm)
Powerstrip SS HO	11-12" (279-305mm)	17" (432mm)	12" (305mm)
	12-18" (305-457mm)	18" (457mm)	12" (305mm)
	18" (457mm)	12" (305mm)	12" (305mm)

**NOTE:** Minimum recommended sign depth is 5 inches (127mm).

## Installation: Sign Without Rails

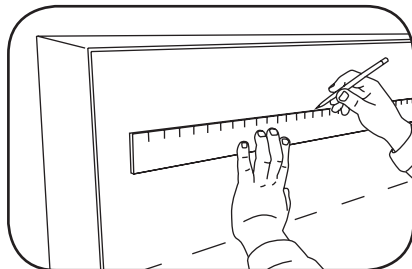

- 1 Mark row spacing guidelines so that modules are spaced evenly inside and from edges of sign.

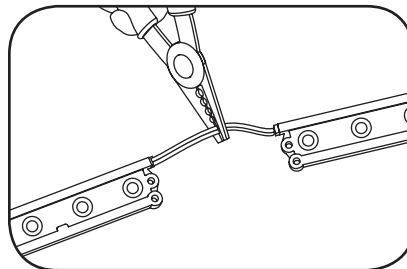

- 2 Determine how many modules are required for one row and cut wire.

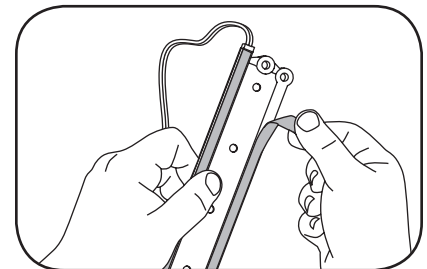

- 3 Peel off backing to expose adhesive tape.

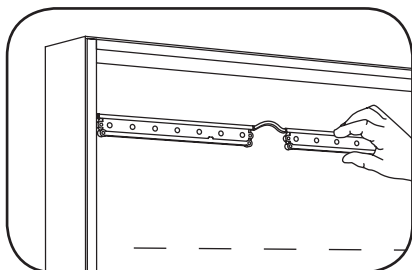

- 4 Position string of modules end to end along guidelines inside of sign. Evenly space modules by arranging approximately one module per 12 inches (305mm).

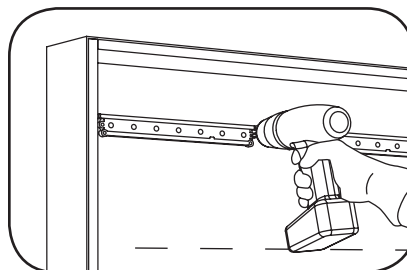

- 5 Secure with at least one screw per module with #6 or #8 (M3 or M4) screws or 1/8-inch rivets (3.175 mm), silicone or equivalent.

## Installation: Sign Using Rails

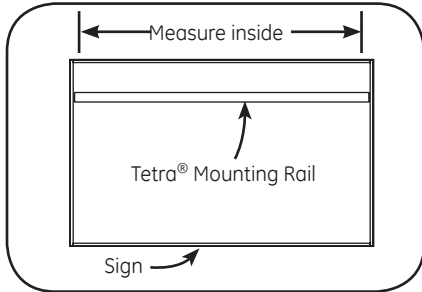

- 1 Measure and cut Tetra® Mounting Rail or other suitable mounting means to appropriate length to fit into sign.

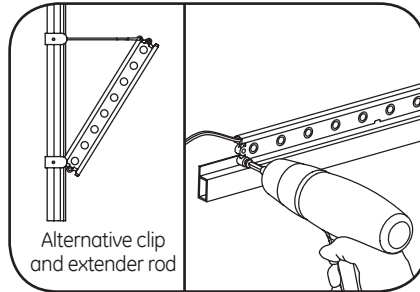

- 2 Arrange modules evenly spaced apart. Place the Tetra® modules on the Mounting Rail and secure into lip with a self-tapping #6 (M3) screw or 1/8-inch (3.175 mm) rivet. Or mount using the alternative clip and extender rod configuration.

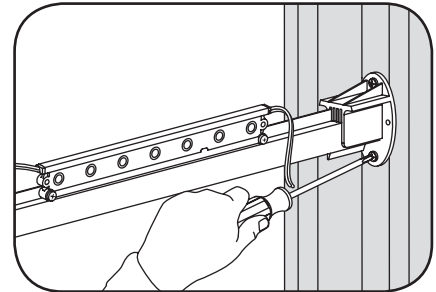

- 3 Secure the Mounting Rail to the inside of the box sign using a Tetra® Mounting Rail Clip or other suitable mounting means. Ensure the #6 (M3) screw does not exceed 3/4 inches (19 mm) in length.

## Electrical Connections

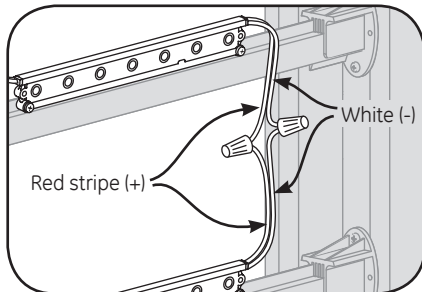

- 1 Connect modules using twist-on wire connectors or in-line (IDC) connectors. Join white wires together and red striped wires together.  
**NOTE:** Additional supply wire may be necessary to bridge electrical connections.

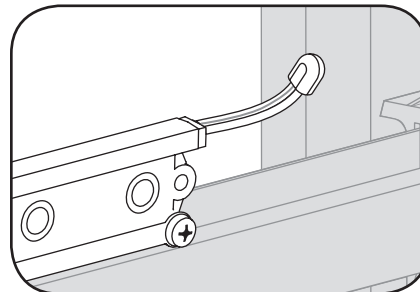

- 2 Cap all exposed wires with appropriate end caps or apply electric grade (non-corrosive) silicone for additional weather protection.

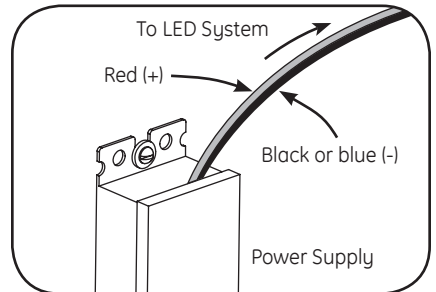

- 3 Run a wire from the power supply to inside the sign and connect to the first module on the strip.  
**NOTE:** Exceeding maximum load will cause the power supply to shut down. If overload occurs, remove excess load, recycle the input power to restart the power supply.

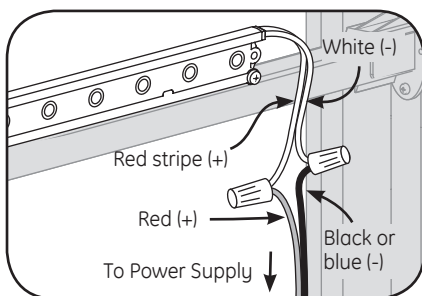

- 4 Connect the red stripe wire (+) of the LED system to the red wire (+) of the power supply. Connect the white wire (-) of the LED system to the black or blue wire (-) of the power supply.

## Retrofit Instructions

1. **(Existing Signs Only)** Prior to installation, survey the site for information regarding power and accessibility inside and outside the building. Ensure that the branch circuit supplying the existing transformer or ballast will be within the voltage ratings of the new LED power supply, and have a current rating not exceeding 20A, or that permitted by applicable local, state, or country electrical codes (whichever is less).
2. **(Existing Signs Only)** Remove the existing lighting equipment to be replaced, such as neon tubing or fluorescent tubes; and associated transformers and ballasts. Care should be taken not to break the existing neon or fluorescent tubes.  
**NOTE:** Follow all federal and local regulations when disposing of neon tubing, fluorescent tubes, transformers and ballasts.
3. **(Existing Signs Only)** If removal of the existing lighting equipment eliminates the disconnect switch, as required by applicable local, state, or country electrical codes; a new disconnect switch must be installed.
4. **(Existing Signs Only)** Repair and seal any unused openings in the electrical enclosure. Openings greater than 12.7-mm (1/2-in) diameter require a metal patch secured by screws or rivets and caulked with non-hardening caulk. Smaller openings may be sealed with non-hardening caulk.

Retrofit instructions continued on next page

5. **(Existing Signs Only)** A clean and dry mounting surface ensures optimum adhesion if the self-adhesive method of mounting is chosen. Follow the manufacturer's directions when using a non-oil based solvent, such as rubbing alcohol to clean the surface area where you intend to mount the module. Before installing, ensure the surface is dry.
6. Using the layout guidelines above, determine required number of LED modules required to illuminate the sign.
7. A Tetra® 24VDC Class 2 Power Supply, as listed below, must be used with this retrofit kit. Using the Maximum Loading chart below, determine the number of Tetra® Class 2 Power Supplies required to power the number of LED modules required to illuminate the sign, so as not to overload the Tetra® Class 2 Power Supply chosen.
8. Follow the instructions above to properly mount the LED modules.
9. Connect the DC output of the power supply to the LED modules using the Electrical Connections instructions above.
10. Connect the power unit to the supply in accordance with the applicable local, state, and country electrical codes, and the instructions found in the power supply installation guide.
11. If required, the disconnect switch shall be installed by qualified personnel, in accordance with applicable local, state, and country electrical codes.

## Troubleshooting

Symptom	Solution
Row of modules does not light	<ul style="list-style-type: none"> <li>• Check wire connections to power supply to ensure red stripe-to-red and white-to-black or blue connections.</li> <li>• Check row-to-row polarity connections.</li> </ul>
Sign does not light	<ul style="list-style-type: none"> <li>• Check input and output voltage and check power supply input/output connections.</li> <li>• Check polarity connections.</li> <li>• Ensure the overall length of the Tetra® LED System does not exceed the maximum load.</li> </ul>
Individual modules do not light	<ul style="list-style-type: none"> <li>• Remove module and replace with another working module.</li> </ul>
Modules are dim	<ul style="list-style-type: none"> <li>• Ensure the overall length of the Tetra® LED system does not exceed the maximum load.</li> <li>• Ensure the length and gauge of the supply wire is equal to or below the recommended remote mounting distance.</li> </ul>

## Specifications

### Maximum Loading per Tetra® 24 VDC Class 2 Power Supply

SKU	Rating	25W Power Supply <i>Note: Load shall not exceed 1.04A</i>	80W Dimming Power Supply <i>Note: Load shall not exceed 3.3A</i>	100W Power Supply <i>Note: Load shall not exceed 4.0A</i>	180W Power Supply <i>Note: Load shall not exceed 4A per each (of 2) output channels</i>	300W PowerSupply <i>Note: Load shall not exceed 4A each (of 3) output channels</i>
GESS2471-2 GESS2450-2 GESS2441-2 GESS2432-2	24VDC 105mA/module 2.52W/module	9 modules	30 modules	36 modules	33 modules per output bank 66 modules per power supply	36 modules per output bank 108 modules per power supply
GESS24H71-2 GESS24H50-2 GESS24H41-2 GESS24H32-2	24VDC 123mA/module 2.95W/module	6 modules	22 modules	30 modules	26 modules per outputbank 52 modules per powersupply	30 modules per output bank 90 modules per power supply

### Maximum Remote Mounting Distance

	18 AWG/0.82 mm <sup>2</sup> Supply Wire	16 AWG/1.31 mm <sup>2</sup> Supply Wire	14 AWG/2.08 mm <sup>2</sup> Supply Wire	12 AWG/3.31 mm <sup>2</sup> Supply Wire
25W Power Supply	120 ft./36.6 m	-	-	-
80W Power Supply	20 ft./6.1 m	25 ft./7.6 m	35 ft./10.6 m	40 ft./12.1 m
100W Power Supply	20 ft./6.1 m	25 ft./7.6 m	35 ft./10.6 m	40 ft./12.1 m
180W Power Supply	20 ft./6.1 m	25 ft./7.6 m	35 ft./10.6 m	40 ft./12.1 m
300W Power Supply	20 ft./6.1 m	25 ft./7.6 m	35 ft./10.6 m	40 ft./12.1 m

This product is intended solely for the use of non-residential signage lighting and is not intended for use in any other applications.

Conforms to the following standards:



**current**  
powered by GE

All trademarks are the property of their respective owners. Information provided is subject to change without notice. All values are design or typical values when measured under laboratory conditions. Current, powered by GE is a business of the General Electric Company.  
© 2018 GE.

