

# LED Power Supply



Outdoor Dimming Driver  
(GED150HCVD1P1050)



# Outdoor Dimming Driver

GED150HCVD1P1050

Description: 150W\_1.05A DALI/Dimmable/Programmable Class1 PSU

Input Voltage: 277V/347V/480V

Input Frequency: 60Hz

ROHS Compliant: Yes



Output Power (W)	Output Current (A)	Output Voltage (V)	Efficiency Full Load	Max Input Current (A)	Max THD @50W Output	Min PF @50W Output	Max Inrush Current (A/mS)	Surge Protection (kV/kA)	Isolated Dimming			Weight (lbs/kg)	IP Rating	
									Protocol	Current Source	Dimming Range @Full Load			
150	0.7 ± 5%	98-215	>89%	0.61 @277V	20%	>0.9	See Page Below	6/3	DALI	0-10V	-	100%-10%	-	IP66
	1.05 ± 5%	70-142		0.49 @347V				0.35 @480V	6/3	DALI	0-10V	-	100%-10%	-

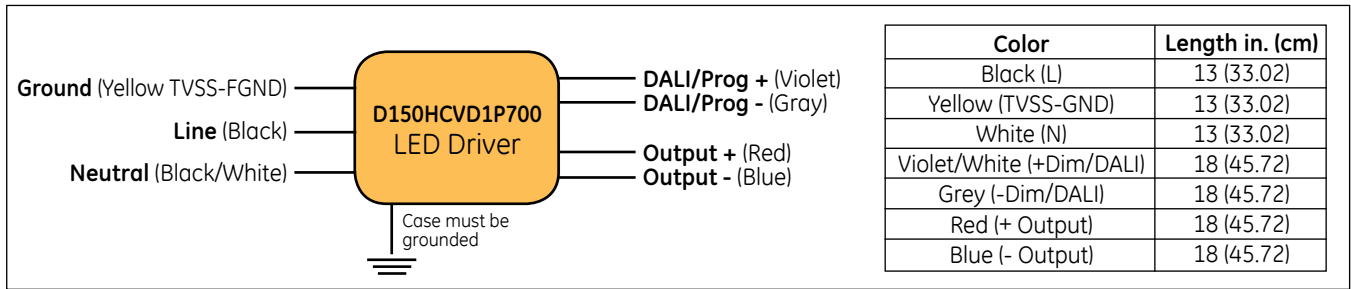

## Product Features

### Physical

- Unit must be installed within an electrical enclosure.
- Enclosure wiring must be rated to 600V & 105°C or higher.
- Use with Grounded 480V Systems Only

### Performance

- The unit is classified as Class 1 as stipulated in UL8750.
- Dimming circuit is classified as Class 2 as stipulated in UL1310.
- Minimum ambient operating temperature: -40°C.
- Maximum allowable casing temperature: 90°C.
- For reliability and failure rate information, contact GE Technical Sales Representative.
- The unit is UL certified for operation in dry/damp locations (Outdoor Type 1).
- The unit is tolerant of extended open circuit and short circuit conditions.
- The unit is compliant to FCC Title 47 Part 15 Class A, The unit is resistant to surges as per IEEE/ANSI C136.2-2015 C LOW (6kV/3kA).
- The unit cannot be hot plug-in at output side.

### UL Conditions of Acceptability – E340135

- The unit has been examined to comply with Class 1 Output Criteria
- The unit is only to be used in dry or damp locations
- The metal casing must be connected to **EARTH**.
- TVSS-FGND (Yellow wire) shall be connected to fixture ground after hi-pot test using closest tab screw. **THIS IS NOT A SAFETY GROUND!**

Input Inrush Current		
Input Voltage (V <sub>rms</sub> )	Peak Current Pulse (A <sub>pk</sub> )	Inrush Current (A) (50% Peak) (us)
277	29.0	20.78
347	40.1	17.78
480	55.4	17.60

# Technical Information

D150HCVD1P1050

### Life Time vs. Case Temperature

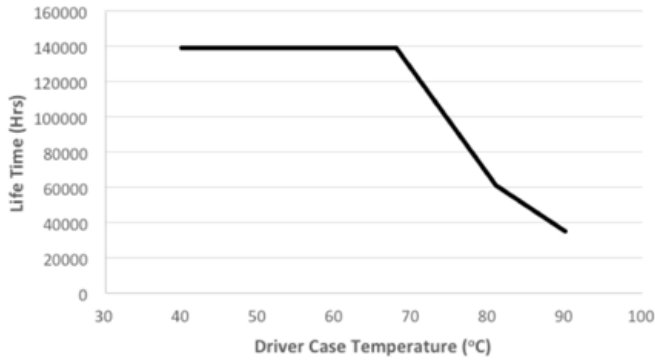

### Output Voltage vs. Output Current

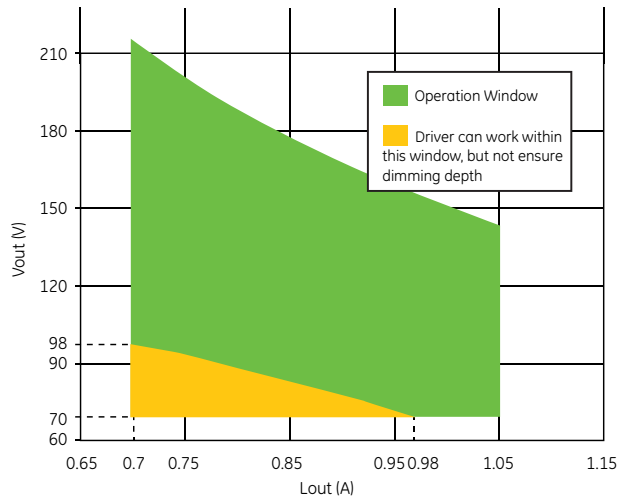

### 0-10V Dimming Curve

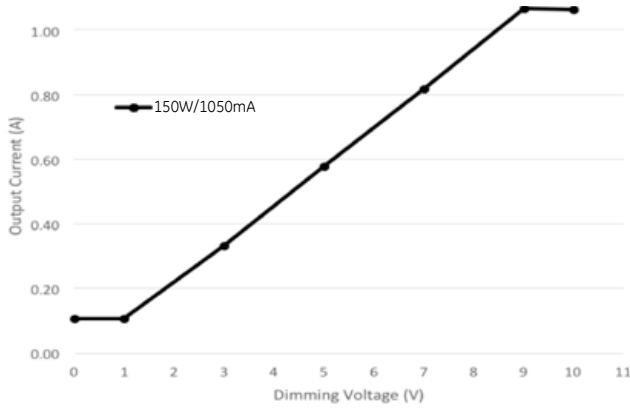

### THD vs. Output Power

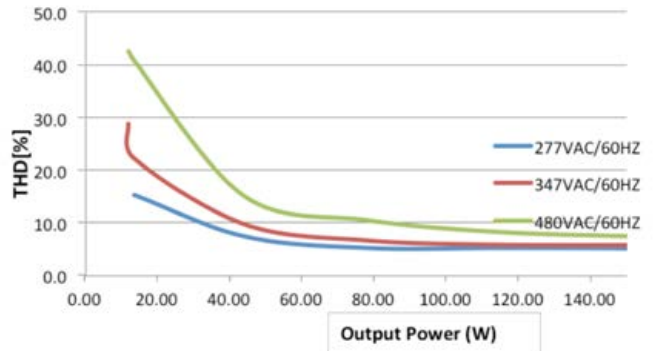

### DALI Dimming Curve

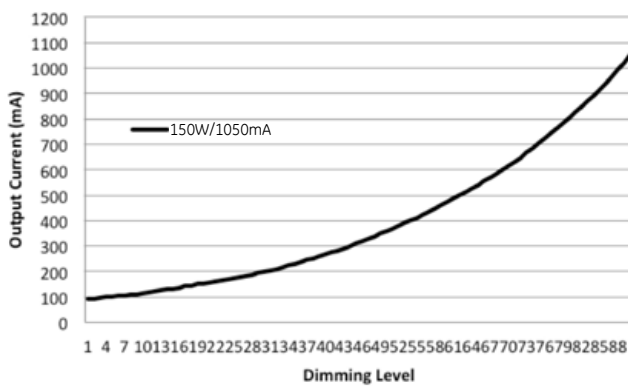

### Efficiency vs. Output Power

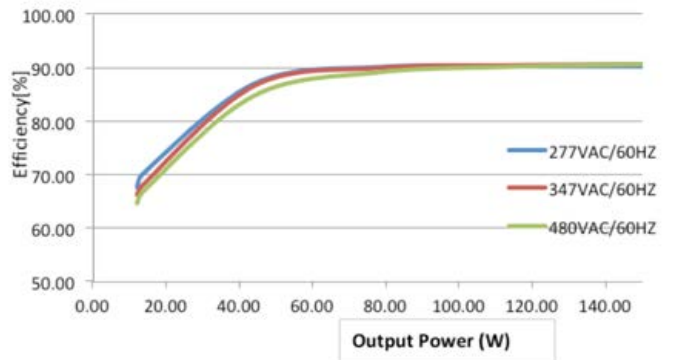

### PF vs. Output Power

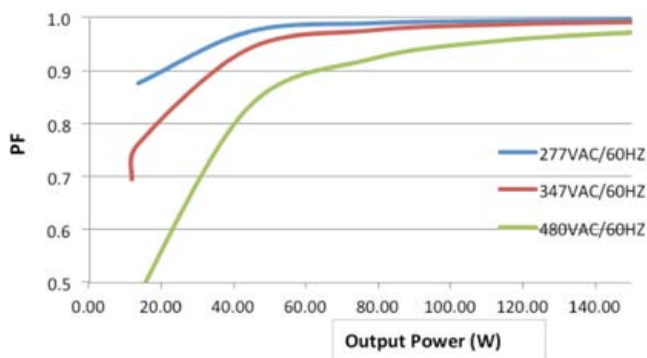

# Product Dimensions

D150HCVD1P1050

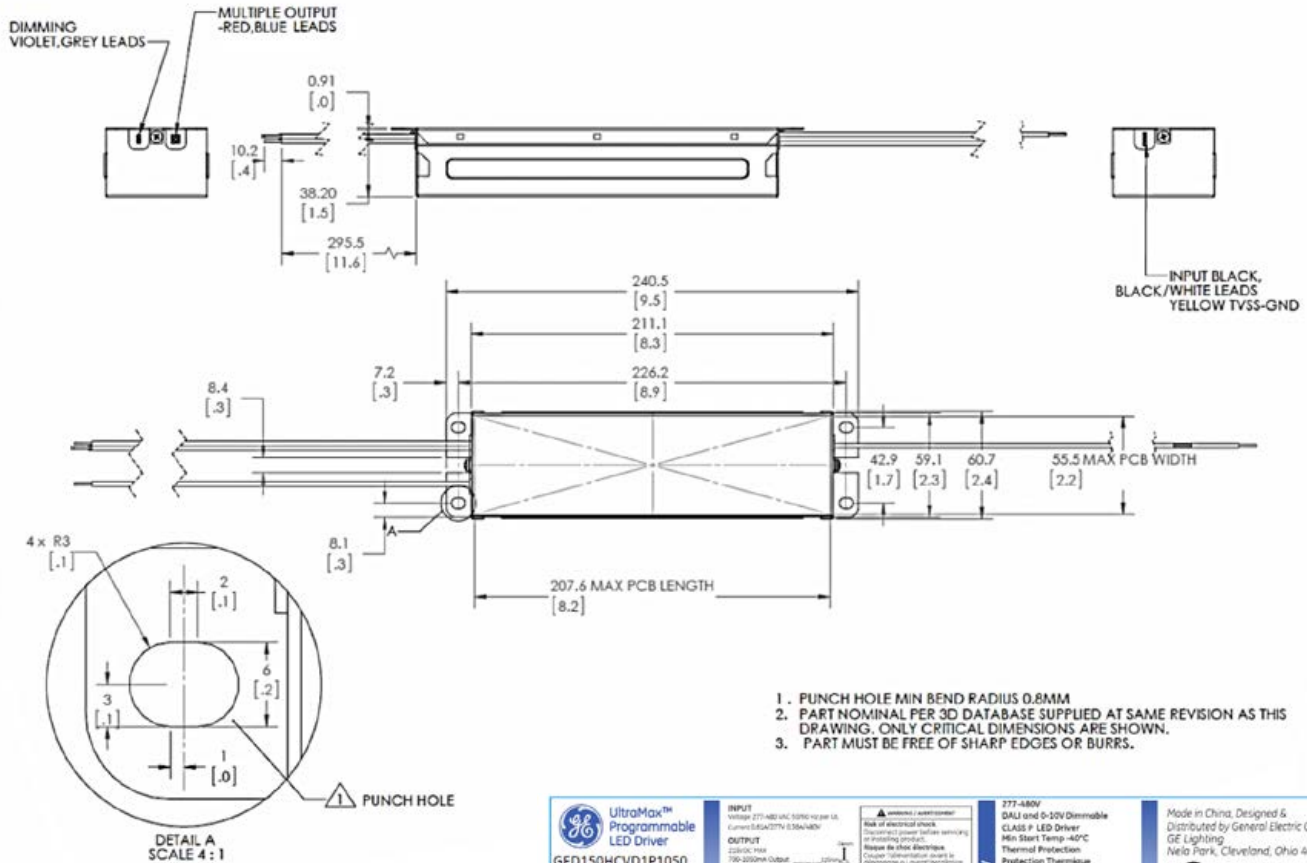

1. PUNCH HOLE MIN BEND RADIUS 0.8MM
2. PART NOMINAL PER 3D DATABASE SUPPLIED AT SAME REVISION AS THIS DRAWING. ONLY CRITICAL DIMENSIONS ARE SHOWN.
3. PART MUST BE FREE OF SHARP EDGES OR BURRS.

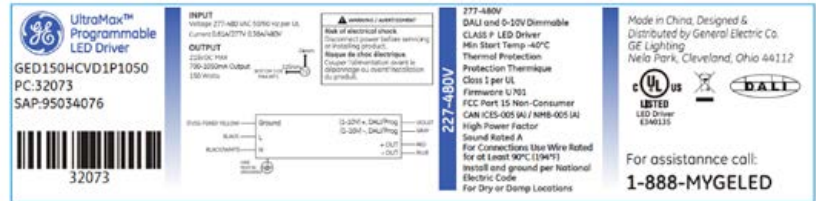

Product Label

# Current Programming Interface

D150HCVD1P700

Firstly open the software (DALI\_NEW\_API) and click the System Temp sheet, then put the value to be programmed (between 0 to 100%) into the Current Programming, finally click the set button to complete the programming of driver.



## Notes

### D150HCVD1P1050

- Two dimming wires can be taken as 0-10V interface, DALI interface and programming interface.
- Used as 0-10V dimming interface, it needs to distinguish polarity, violet wire connects to 0-10V '+', and gray wire connects to 0-10V '-', the same as all 0-10V drivers.
- Used as DALI interface, no need to judge polarity.
- Used as programmable interface, the driver needs to be in 'DALI mode'.

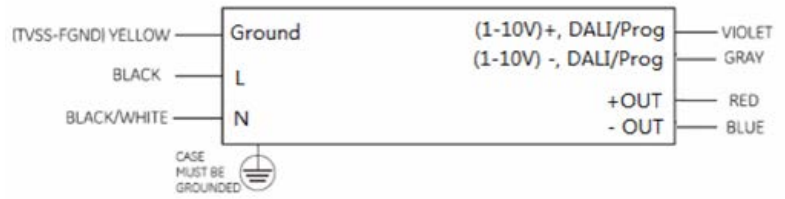

- When use GUI to switch 'DALI mode' to '0-10V' mode, because 0-10V needs distinguish polarity and tridronic power DALI BUS also has polarity, when connecting violet wire to DALI BUS '+', and gray wire to DALI BUS '-', the driver will work in full power output. If versus, the driver will work in 10% dimming condition.

## 0-10V and DALI Switch Over

### 1. 0-10V to DALI

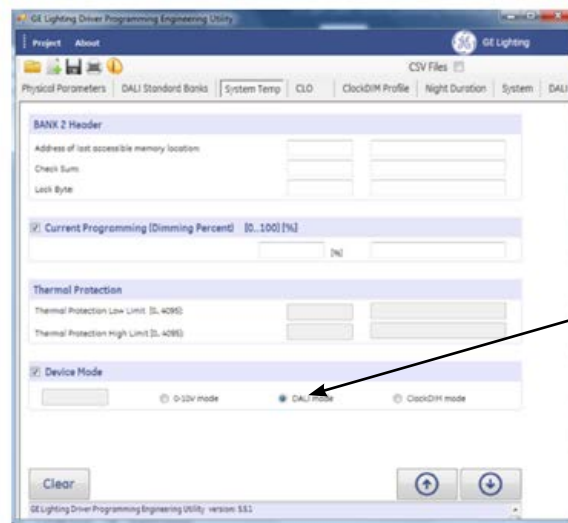

### 2. DALI to 0-10V

Below two conditions are both normal by 'Notes'

- If the Violet wire connects to DALI BUS '+', and grey wire connects to DALI BUS '-' (as shown in Fig 1), when switch to 0-10V mode, the output current of LED is the same as the programmable value.
- If the Violet wire connects to DALI BUS '-', and grey wire connects to DALI BUS '+', the output current of LED is the 10% dimming value. When disconnected, the output current goes back to the programmable value.

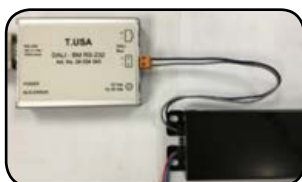
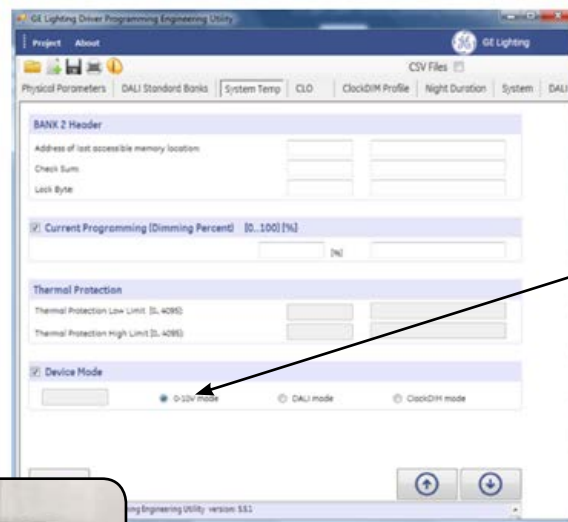

Figure 1



Figure 2