

Evolve™ LED Area Lighting

EALS



current
powered by GE



Product Features

The EAL Area Light luminaires are the newest members of the GE Evolve™ LED Area Light family. They offer a wide range of optical patterns, color temperatures, lumen packages, and mounting configurations to best optimize area light applications, as well as provide versatility in lighting design within the same form-factor. They are available in a standard and premium and perfect for commercial property site-lighting applications such as retail locations or commercial offices. The “standard” EALS area light, has a lumen range from 10,000–34,000 lumens with an efficacy point up to 146 LPW. These luminaires feature innovative heat sinking that produces thermal stability over life in an extremely lightweight housing, while meeting a 3G vibration rating tested on 3-axis.

The GE Evolve™ LED EALS Area Light is intended to replace up to 1000W MH luminaires. It features 0-10V or DALI dimming, along with LightGrid™ wireless control compatibility and is available with optional programmable motion sensing for additional energy savings and Title 24 compliance. The Universal Mounting Area option enables luminaires to mount to round poles ranging in size from 2.38” to 6” in diameter or on square poles.

Applications

- Site, area, roadway and general lighting applications utilizing advanced LED optical system providing high uniformity, excellent vertical light distribution, reduced offsite visibility, reduced on-site glare and effective security light levels.
- Ideal for large retailers, commercial to medical properties, and big box retailers. Also suitable for roadways.

Housing

- Slim architectural design incorporates an integral heat sink and light engine, ensuring maximum heat transfer, and long LED life.
- Die cast aluminum housing
- 3G vibration per ANSI C136.31-2010

LED & Optical Assembly

- LM-79 tests and reports in accordance with IESNA standards
- 70CRI at 3000K, 4000K and 5000K
- Distributions: II, III, IV, V (short & medium)
- Upward Light Output Ratio (ULOR) = 0

Lumen Maintenance

- Projected Lxx per IES TM-21 at 25 °C for reference:

OPTICAL CODE	Lxx (10k) @ Hours			PROJECTED L90
	25,000 hr	50,000 hr	100,000 hr	
D4, D3, D2	L95	L91	L84	60,000
F4, F3, F2	L93	L86	L74	37,000
F5, Q5, N5, D5	L96	L94	L89	>61,000
H5, H4, H3, H2, S5	L95	L91	L84	60,000
J5, J4, J3, J2, T5	L89	L80	L64	25,000
K5, K4, K3, K2, KA, U5	L87	L76	L57	20,000

NOTES: 1) Projected Lxx based on LM80 (10,000 hour testing). 2) DOE Lighting Facts Verification Testing Tolerances apply to initial luminous flux and lumen maintenance measurements.

Lumen Ambient Temperature Factors:

Ambient Temp (°C)	Initial Flux Factor
10	1.02
20	1.01
25	1.00
30	0.99
35	0.98

Ratings

-  cUL Listed
-  UL 1598 Listed Suitable for Wet Locations

- IP65 optical enclosure per ANSI C136.25-2013
- Temperature Rated -40°C to +40°C
- Title 24 compliant (w/ “H” motion sensor option)
- Complies with the material restrictions of RoHS.

Mounting

Option C: C1 = Integral Slipfitter 2” Pipe (2.378 in. OD) supplied with leads.

Option D: D1 = Universal Mounting Arm, fitted for round or square pole mounting supplied with 16/3 3ft cable.

Option K: K1 = Knuckle Slipfitter for 1.9 in. -2.3 in. OD Tenon with leads. Restricted aiming angle 0° to +45°.

Option S: S1 = Knuckle Slipfitter for 2.3in. - 3.0in OD Tenon with leads. Restricted aiming angle 0° to +45°.

Option V: V1 = Knuckle Wall Mount with leads. Restricted aiming angle 0° to +45°.

Finish

- Corrosion resistant polyester powder paint, minimum thickness 2.0 mil.
- Standard colors: Black & Dark Bronze.
- RAL & custom colors available.

Electrical

- 120-277 VAC and 347-480 VAC available.
- System power factor is >90% and THD <20%.
- ANSI C136.41 7-pin dimming receptacle, standard.
- ANSI photo electric sensors (PE) available for all voltages. Light Grid compatible.
- Dimming/Occupancy:
 - Wired 0-10V continuous dimming
 - DALI digital dimming. Contact manufacturer for availability.
 - Standalone motion sensor based dimming using “H” option code.
- Surge Protection per ANSI C136.2-2015.
 - 6kV/3kA “Basic” surge protection, standard.
 - 10kV/5kA “Enhanced” surge protection optional.

Warranty

- 5 Year Standard

Accessories

- Photoelectric Controls (see page 7)
- Light Shields (see OLP 3120 Shielding for EAL Area Light Fixtures)



DLC Standard qualified models available. Please refer to <http://www.designlights.org/QPL> for complete information.

Ordering Number Logic

Evolve™ LED Area Light (EALS)



EALS 02 7

PROD. ID	GENERATION	VOLTAGE	OPTICAL DISTRIBUTION CODE	CRI	CCT	DIMMING	CONTROLS	MOUNTING ARM	COLOR	OPTIONS
E = Evolve AL = Area Light S = Standard	02 = 2nd Generation	0 = 120-277* 1 = 120 2 = 208 3 = 240 4 = 277 5 = 480 D = 347 H = 347-480*	SM = Symmetric Medium SW = Symmetric Wide AF = Asymmetric Forward AW = Asymmetric Wide AN = Asymmetric Narrow AA = Asymmetric Auto*	7 = 70 (min)	30 = 3000K 40 = 4000K 50 = 5000K	N = Dimming thru PE receptacle D = External Dimming 3ft #18/2 Cable All constructions supplied with ANSI C136.41 7-pin Receptacle Note: Standard dimming 0-10V	A = ANSI 7-pin PE receptacle (no control) D = ANSI 7-pin PE receptacle with shorting cap provided Note: See accessories section on page 7 for PE Control ordering	C1 = Integral Slip-fitter 2" Pipe (2.378 in. OD)* D1 = Universal Mounting Arm, fitted for round or square pole mounting** K1 = Knuckle Slipfitter for 1.9 in - 2.3in. OD Tenon* ++ S1 = Knuckle Slipfitter for 2.3in. - 3.0in OD Tenon* ++ V1 = Knuckle Wall Mount* ++	GRAY = Gray BLCK = Black DKBZ = Dark Bronze WHTE = White	F = Fusing H = Motion Sensor J = cUL/Canada L = Tool-Less Entry R = Enhanced Surge Protection (10kV/5kA) S1 = Rotated Left† S2 = Rotated Right† M = NOM031 (Mexico)* U = DALI dimming+ ^ V = 3-Position Terminal Block XXX = Special Options * Contact Manufacturer for availability + Compatible with LightGrid 2.0 nodes ^ Not compatible at 347-480V or with motion sensor control † For aimed left or right light distribution orientation, as assembled in manufacturing. Not applicable for Symmetric or Asymmetric Auto Distributions.

* AA distribution not available with options S1 and S2

* Supplied with 3FT 14-7 leads
** Supplied with 3ft #14/3 power cable
++ Restricted Aiming Angle 0° to +45°

Left (S1)

Right (S2)

	OPTICAL CODE	DISTRIBUTION	TYPICAL INITIAL LUMENS		TYPICAL SYSTEM WATTAGE		BUG RATING			IES FILE NUMBER		
			3000K	4000K & 5000K	120-277V & 347-480V	B	U	G	3000K	4000K	5000K	
TYPE V	D5	Symmetric Medium	9700	10000	74	3	0	2	EALS02_D5SM730_____IES	EALS02_D5SM740_____IES	EALS02_D5SM750_____IES	
	F5	Symmetric Medium	14400	15000	119	4	0	2	EALS02_F5SM730_____IES	EALS02_F5SM740_____IES	EALS02_F5SM750_____IES	
	H5	Symmetric Medium	19500	20000	171	4	0	2	EALS02_H5SM730_____IES	EALS02_H5SM740_____IES	EALS02_H5SM750_____IES	
	J5	Symmetric Medium	24300	25000	230	5	0	3	EALS02_J5SM730_____IES	EALS02_J5SM740_____IES	EALS02_J5SM750_____IES	
	K5	Symmetric Medium	28100	28700	281	5	0	3	EALS02_K5SM730_____IES	EALS02_K5SM740_____IES	EALS02_K5SM750_____IES	
	N5	Symmetric Wide	10500	10800	74	3	0	1	EALS02_N5SW730_____IES	EALS02_N5SW740_____IES	EALS02_N5SW750_____IES	
	Q5	Symmetric Wide	15700	16200	119	4	0	2	EALS02_Q5SW730_____IES	EALS02_Q5SW740_____IES	EALS02_Q5SW750_____IES	
	S5	Symmetric Wide	21000	21600	171	4	0	2	EALS02_S5SW730_____IES	EALS02_S5SW740_____IES	EALS02_S5SW750_____IES	
	T5	Symmetric Wide	26400	27100	230	5	0	2	EALS02_T5SW730_____IES	EALS02_T5SW740_____IES	EALS02_T5SW750_____IES	
U5	Symmetric Wide	30200	31000	281	5	0	2	EALS02_U5SW730_____IES	EALS02_U5SW740_____IES	EALS02_U5SW750_____IES		
TYPE IV	D4	Asymmetric Forward	9700	10000	87	2	0	2	EALS02_D4AF730_____IES	EALS02_D4AF740_____IES	EALS02_D4AF750_____IES	
	F4	Asymmetric Forward	14500	15000	137	2	0	3	EALS02_F4AF730_____IES	EALS02_F4AF740_____IES	EALS02_F4AF750_____IES	
	H4	Asymmetric Forward	19500	20000	171	3	0	4	EALS02_H4AF730_____IES	EALS02_H4AF740_____IES	EALS02_H4AF750_____IES	
	J4	Asymmetric Forward	24300	25000	230	3	0	4	EALS02_J4AF730_____IES	EALS02_J4AF740_____IES	EALS02_J4AF750_____IES	
	K4	Asymmetric Forward	28100	28700	281	3	0	4	EALS02_K4AF730_____IES	EALS02_K4AF740_____IES	EALS02_K4AF750_____IES	
TYPE III	D3	Asymmetric Wide	10500	10800	87	2	0	2	EALS02_D3AW730_____IES	EALS02_D3AW740_____IES	EALS02_D3AW750_____IES	
	F3	Asymmetric Wide	15600	16100	137	2	0	2	EALS02_F3AW730_____IES	EALS02_F3AW740_____IES	EALS02_F3AW750_____IES	
	H3	Asymmetric Wide	21000	21600	171	3	0	2	EALS02_H3AW730_____IES	EALS02_H3AW740_____IES	EALS02_H3AW750_____IES	
	J3	Asymmetric Wide	26400	27100	230	3	0	3	EALS02_J3AW730_____IES	EALS02_J3AW740_____IES	EALS02_J3AW750_____IES	
	K3	Asymmetric Wide	30200	31000	281	3	0	3	EALS02_K3AW730_____IES	EALS02_K3AW740_____IES	EALS02_K3AW750_____IES	
TYPE II	D2	Asymmetric Narrow	10300	10600	87	2	0	2	EALS02_D2AN730_____IES	EALS02_D2AN740_____IES	EALS02_D2AN750_____IES	
	F2	Asymmetric Narrow	15300	15900	137	3	0	3	EALS02_F2AN730_____IES	EALS02_F2AN740_____IES	EALS02_F2AN750_____IES	
	H2	Asymmetric Narrow	20700	21300	171	3	0	3	EALS02_H2AN730_____IES	EALS02_H2AN740_____IES	EALS02_H2AN750_____IES	
	J2	Asymmetric Narrow	25900	26600	230	3	0	3	EALS02_J2AN730_____IES	EALS02_J2AN740_____IES	EALS02_J2AN750_____IES	
	K2	Asymmetric Narrow	29700	30500	281	3	0	3	EALS02_K2AN730_____IES	EALS02_K2AN740_____IES	EALS02_K2AN750_____IES	
AUTO	KA	Asymmetric Auto	33400	34000	281	4	0	3	EALS02_KAAA730_____IES	EALS02_KAAA740_____IES	EALS02_KAAA750_____IES	

Photometrics

Evolve™ LED Area Light (EALS)

EALS Type V - Symmetric Medium (K5)
 28,700 Lumens, 5000K (EALS02_K5SM750____.IES)

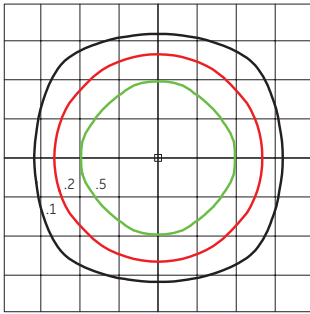

Grid Distance in Units of Mounting Height at 40' Initial Footcandle Values at Grade

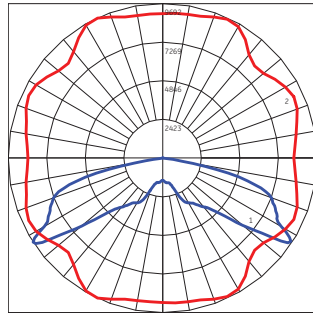

— Vertical plane through horizontal angle of maximum candlepower at 115°
 — Vertical plane through horizontal angle of 57°

EALS Type V - Symmetric Wide (U5)
 31,000 Lumens, 5000K (EALS02_U5SW750____.IES)

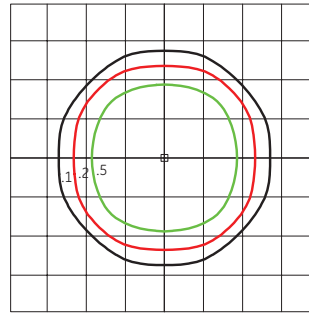

Grid Distance in Units of Mounting Height at 40' Initial Footcandle Values at Grade

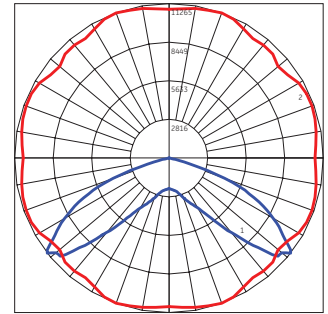

— Vertical plane through horizontal angle of maximum candlepower at 70°
 — Vertical plane through horizontal angle of 52°

EALS Type IV - Asymmetric Forward (K4)
 28,700 Lumens, 5000K (EALS02_K4AF750____.IES)

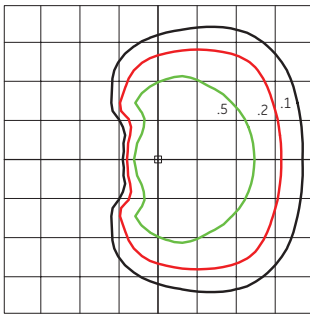

Grid Distance in Units of Mounting Height at 40' Initial Footcandle Values at Grade

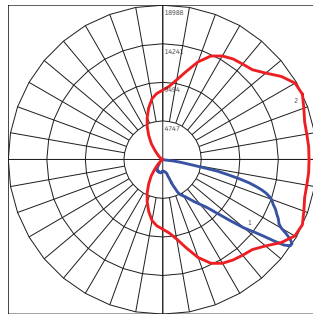

— Vertical plane through horizontal angle of maximum candlepower at 25°
 — Vertical plane through horizontal angle of 57°

EALS Type III - Asymmetric Wide (K3)
 31,000 Lumens, 5000K (EALS02_K3AW750____.IES)

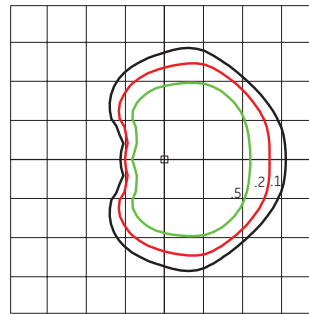

Grid Distance in Units of Mounting Height at 40' Initial Footcandle Values at Grade

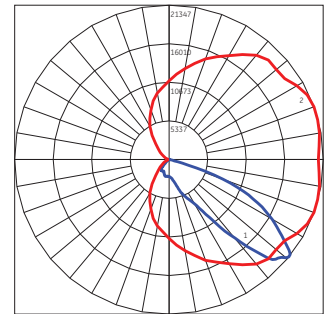

— Vertical plane through horizontal angle of maximum candlepower at 20°
 — Vertical plane through horizontal angle of 51°

EALS Type II - Asymmetric Narrow (K2)
 30,500 Lumens, 5000K (EALS02_K2AN750____.IES)

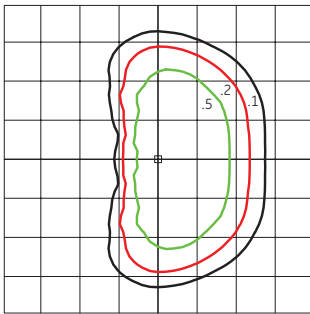

Grid Distance in Units of Mounting Height at 40' Initial Footcandle Values at Grade

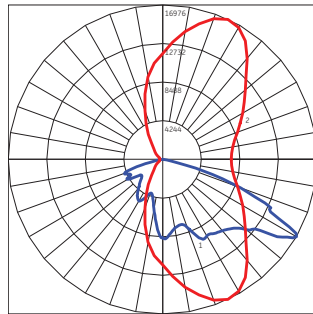

— Vertical plane through horizontal angle of maximum candlepower at 65°
 — Vertical plane through horizontal angle of 60°

EALS - Assymmetric Auto (KA)
 34,200 Lumens, 5000K (EALS02_KAAA750____.IES)

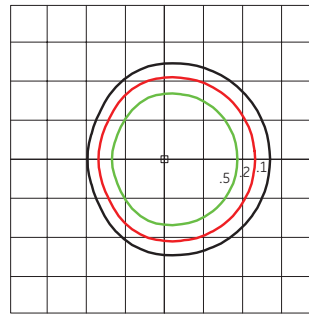

Grid Distance in Units of Mounting Height at 40' Initial Footcandle Values at Grade

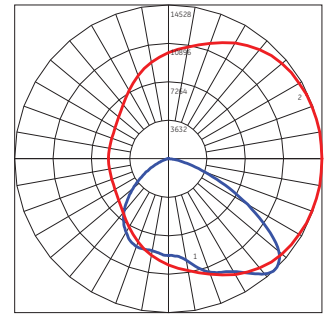

— Vertical plane through horizontal angle of maximum candlepower at 0°
 — Vertical plane through horizontal angle of 44°

Product Dimensions

Evolve™ LED Area Light (EALS)

Slipfitter Mount

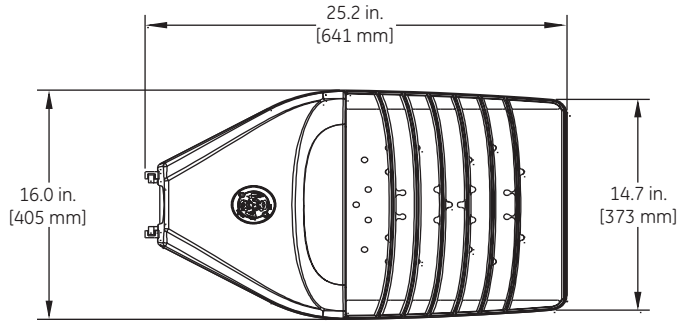

TOP VIEW

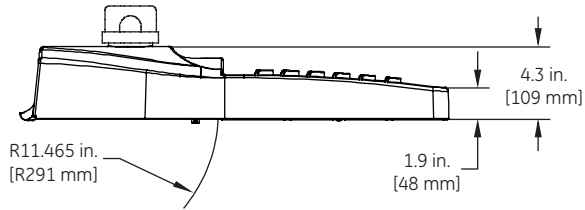

SIDE VIEW

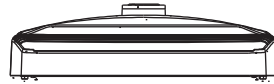
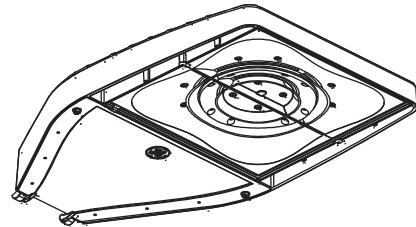

FRONT VIEW

Knuckle Mount

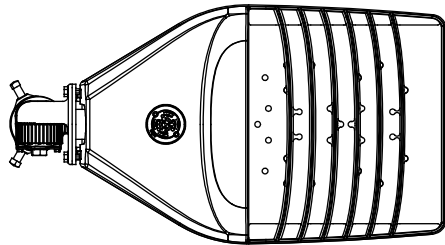

TOP VIEW

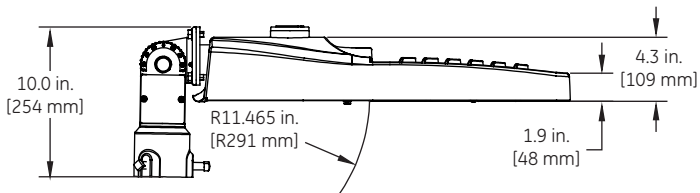

SIDE VIEW

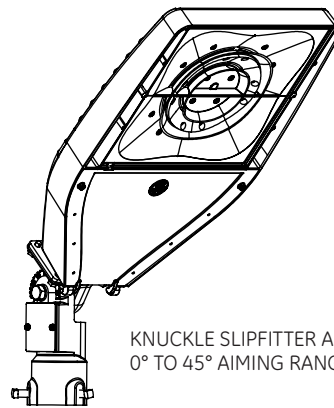

KNUCKLE SLIPFITTER ARM MOUNT
0° TO 45° AIMING RANGE

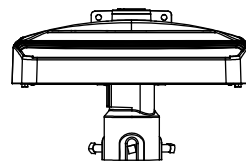

FRONT VIEW

Product Dimensions

Evolve™ LED Area Light (EALS)

Universal Arm Mount

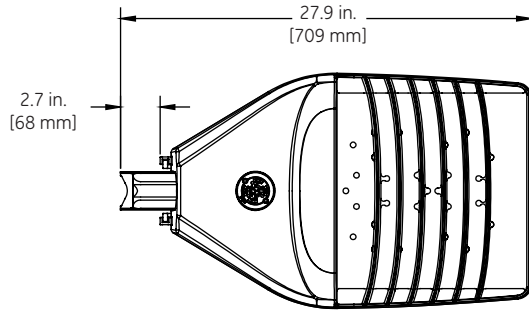

TOP VIEW

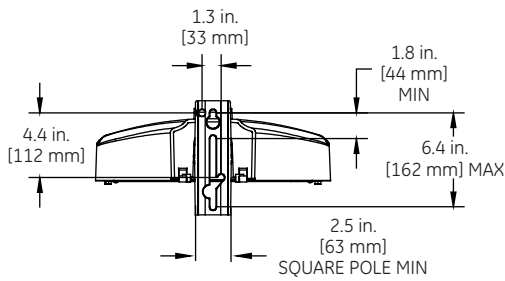
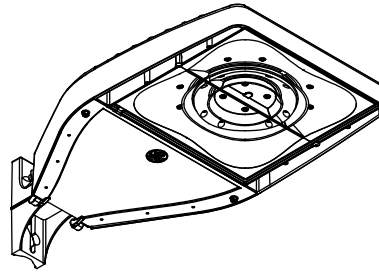

BACK VIEW

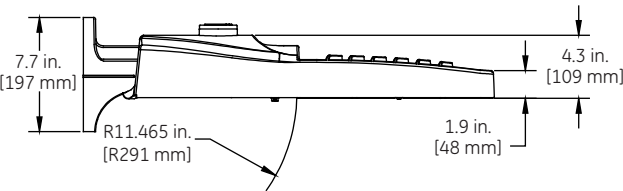

SIDE VIEW

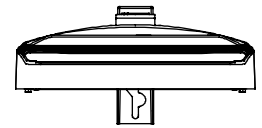

FRONT VIEW

Knuckle Wall Mount

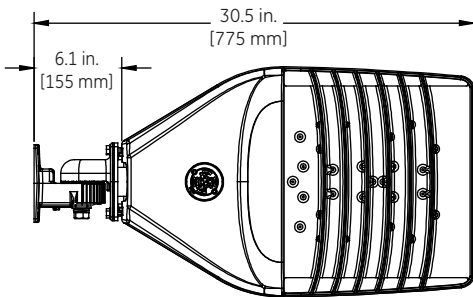

TOP VIEW

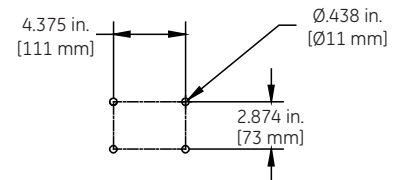
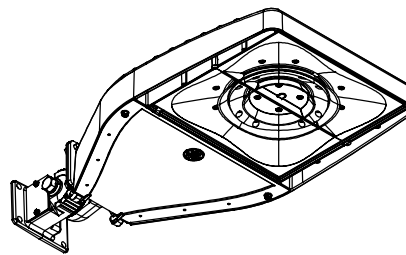

Wall Mount Hole Pattern

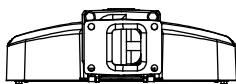

BACK VIEW

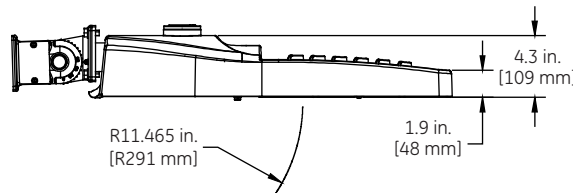

SIDE VIEW

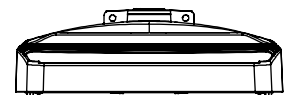

FRONT VIEW

DATA

- Approximate Net Weight: 26-28 lbs (11.79 kgs-12.97 kgs)
- Effective Projected Area (EPA):
 - Knuckle Slipfitter S1, 45° aim, EPA = 2.45
 - Knuckle w/Slipfitter S1, downward aim, EPA = 0.73
 - Universal Arm Mount D1, EPA = 0.54
 - Knuckle Wall Mount V1, 45° aim, EPA = 0.77 sq ft min and 1.43 sq ft max
 - Integral Slipfitter C1, EPA = 0.63

Accessories

Evolve™ LED Area Light (EALS)

PE Accessories (to be ordered separately)

SAP Number	Part Number	Description
93029237	PED-MV-LED-7	ANSI C136.41 Dimming PE, 120-277V
93029238	PED-347-LED-7	ANSI C136.41 Dimming PE, 347V
93029239	PED-480-LED-7	ANSI C136.41 Dimming PE, 480V

SAP Number	Part Number	Description
28299	PECOTL	STANDARD 120-277V
28294	PEC5TL	STANDARD 480V
80436	PECCTL	STANDARD 347V
73251	SCCL-PECTL	Shorting cap

H-Motion Sensing Option

- Intended for applications, between 15-30 ft. mounting height. (4.57-9.14m). For mounting heights exceeding 30 ft., pole mounted sensors are recommended.
- Provides a coverage area radius for walking motion of 15-20 ft. (4.57-6.10m).
- Provides 270° of coverage (~90° is blocked by the pole).
- Standard factory settings:
 - 50% output when unoccupied, 100% output occupied.
 - Integral PE Sensor.
 - 5 minute post-occupancy time delay, 5 minute dimming ramp-down.
- Fixture power increase of 1W expected with sensor use.

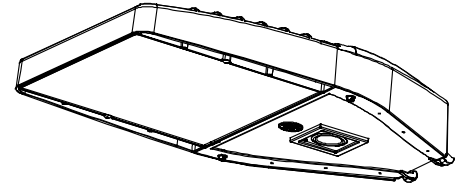

Note: Standard options may be reprogrammed in the field. Reprogramming instructions included in product shipment.

Sensor Pattern

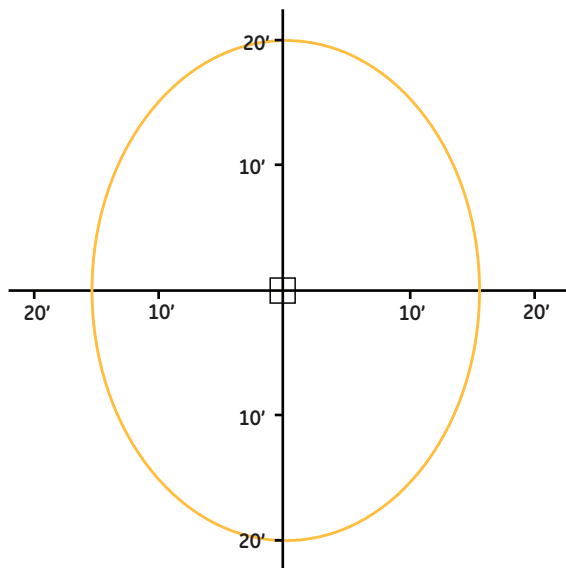

**Sensing Pattern Area Fixture
Up to 30 ft. Mounting Height**

Mounting Information

Mounting Arms for Slipfitter

Order separately with Mounting Option C1 (Slipfitter)

SQUARE POLE MOUNTING ARM

3.5 TO 4.5-inch (89 to 114mm) SQUARE
(WILL ALLOW 4 FIXTURES PER POLE @ 90 DEGREES.)

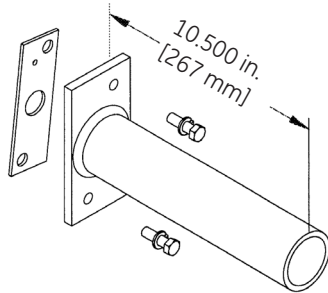

ORDER SEPARATELY FROM FIXTURE AS CATALOG NUMBER
SPA-EAMT10BLCK "Black"
SPA-EAMT10DKBZ "Dark Bronze"

SQUARE POLE MOUNTING DRILLING TEMPLATE

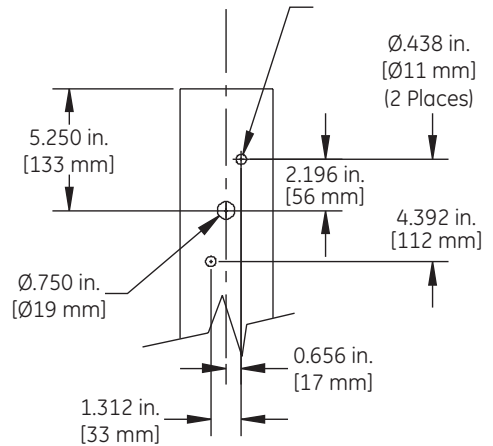

ROUND POLE MOUNTING ARM DRILLING TEMPLATE

3.5 TO 4.5-inch (89 to 114mm) OD
(WILL ALLOW 4 FIXTURES PER POLE @ 90 DEGREES.)

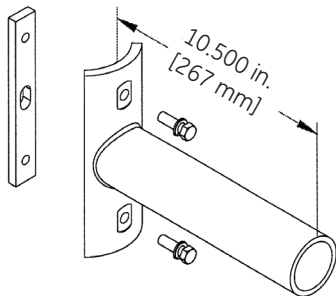

ORDER SEPARATELY FROM FIXTURE AS CATALOG NUMBER
RPA-EAMT10BLCK "Black"
RPA-EAMT10DKBZ "Dark Bronze"

ROUND POLE MOUNTING DRILLING TEMPLATE

3.5 TO 4.5-inch (89 to 114mm) OD
round pole mounting arm

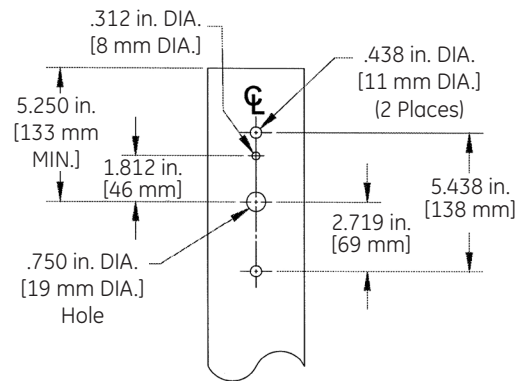

Wall Mounting Bracket Adapter Plate

ORDER SEPARATELY FROM FIXTURE AS CATALOG NUMBER
WMB-EAMT06

***NOTE: For Wall Mounting, order luminaire with mounting arm: C1 = Slipfitter 2" Pipe (2.378 in. OD) supplied with leads.**

Other mounting patterns are available for retrofit installations.
Contact manufacturing for other available mounting patterns.