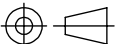
	<b>PROPRIETARY AND CONFIDENTIAL</b> THE INFORMATION CONTAINED IN THIS DRAWING IS THE SOLE PROPERTY OF <b>GE LIGHTING SOLUTIONS, LLC</b> 1940 ONÉSIME GAGNON LACHINE, QUÉBEC, CANADA H8T 3M6 ANY REPRODUCTION IN PART OR AS A WHOLE WITHOUT THE WRITTEN PERMISSION OF <b>GE LIGHTING SOLUTIONS, LLC</b> IS PROHIBITED.		UNLESS OTHERWISE SPECIFIED UNITS ARE MM		DRAWING DESCRIPTION <b>Ultron Retrofit 4 foot assembly</b>																
	THIS DOCUMENT IS ELECTRONICALLY SIGNED AND CONTROLLED IN A DATA MANAGEMENT SYSTEM. DO NOT SCALE DRAWING INTERPRET DRAWING PER ASME 14.5M 1994		<table border="1"> <tr> <td>.X DECIMALS</td> <td>±.2</td> </tr> <tr> <td>.XX DECIMALS</td> <td>±.10</td> </tr> <tr> <td>.XXX DECIMALS</td> <td>±.010</td> </tr> <tr> <td>ANGLES</td> <td>±2°</td> </tr> <tr> <td>INSPECTION DIM</td> <td>○</td> </tr> <tr> <td>PPAP DIM</td> <td>◆</td> </tr> </table>		.X DECIMALS	±.2	.XX DECIMALS		±.10	.XXX DECIMALS	±.010	ANGLES	±2°	INSPECTION DIM	○	PPAP DIM	◆	DRAWING NUMBER REVISION <b>-A-NR Editing</b>		LIFE CYCLE STATUS DRAWN DATE <b>2017-05-31</b>	
	.X DECIMALS	±.2																			
	.XX DECIMALS	±.10																			
.XXX DECIMALS	±.010																				
ANGLES	±2°																				
INSPECTION DIM	○																				
PPAP DIM	◆																				
DRAWN BY <b>Ghalayini, Jana(Current by GE)</b>			APPROVED BY		APPROVED DATE		SIZE <b>B</b>														
							SHEET <b>1/4</b>														

1

2

3

4

5

E

E

D

D

C

C

B



B

A

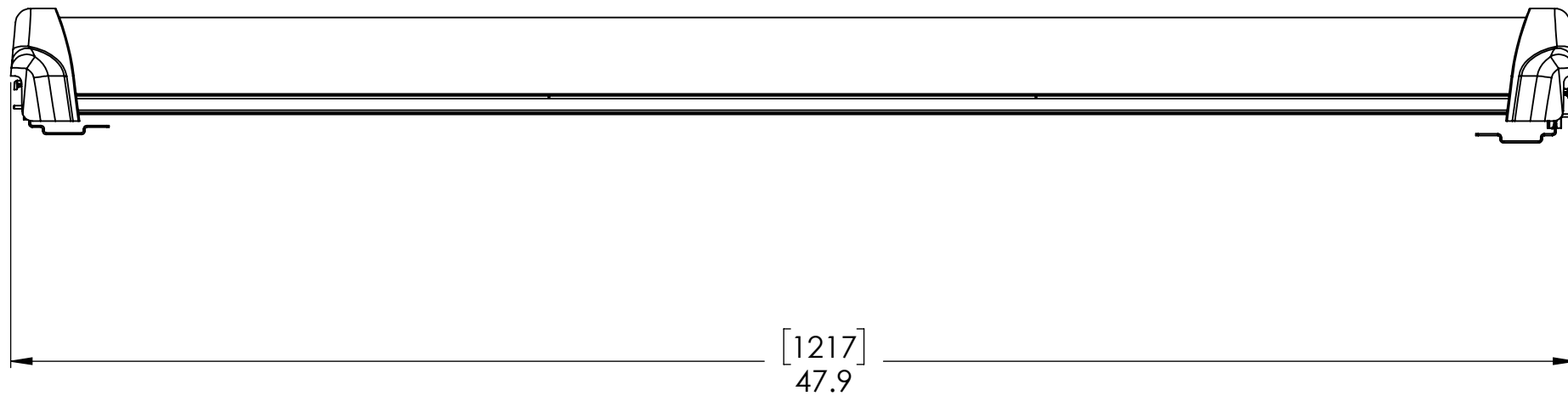
A

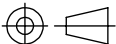

[1217]  
47.9

	<b>PROPRIETARY AND CONFIDENTIAL</b> THE INFORMATION CONTAINED IN THIS DRAWING IS THE SOLE PROPERTY OF <b>GE LIGHTING SOLUTIONS, LLC</b> 1940 ONÉSIME GAGNON LACHINE, QUÉBEC, CANADA H8T 3M6 ANY REPRODUCTION IN PART OR AS A WHOLE WITHOUT THE WRITTEN PERMISSION OF GE LIGHTING SOLUTIONS, LLC IS PROHIBITED.		UNLESS OTHERWISE SPECIFIED UNITS ARE MM		DRAWING DESCRIPTION <b>Ultron Retrofit 4 foot assembly</b>			
	THIS DOCUMENT IS ELECTRONICALLY SIGNED AND CONTROLLED IN A DATA MANAGEMENT SYSTEM. DO NOT SCALE DRAWING INTERPRET DRAWING PER ASME 14.5M 1994		.X DECIMALS ±.2 .XX DECIMALS ±.10 .XXX DECIMALS ±.010 ANGLES ±2° INSPECTION DIM  PPAP DIM 	DRAWING NUMBER DRAWN BY <b>Ghalayini, Jana(Current by GE)</b> APPROVED BY		REVISION <b>-A-NR</b> LIFE CYCLE STATUS <b>Editing</b>	DRAWN DATE <b>2017-05-31</b> APPROVED DATE	

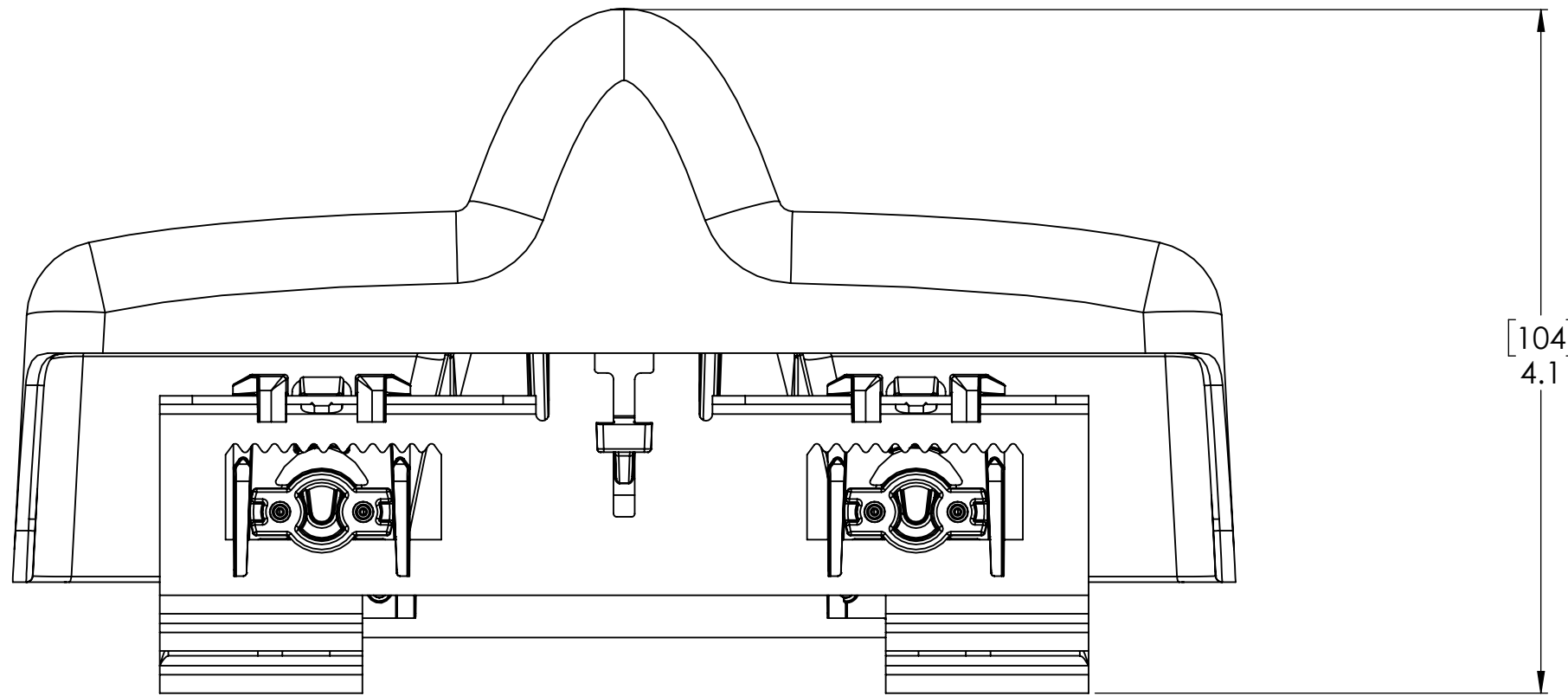

[104]  
4.1



**PROPRIETARY AND CONFIDENTIAL**  
 THE INFORMATION CONTAINED IN THIS DRAWING IS THE SOLE  
 PROPERTY OF  
**GE LIGHTING SOLUTIONS, LLC**  
 1940 ONÉSIME GAGNON LACHINE, QUÉBEC, CANADA H8T 3M6  
 ANY REPRODUCTION IN PART OR AS A WHOLE WITHOUT THE  
 WRITTEN PERMISSION  
 OF **GE LIGHTING SOLUTIONS, LLC** IS PROHIBITED.  
 THIS DOCUMENT IS ELECTRONICALLY SIGNED  
 AND CONTROLLED IN A DATA MANAGEMENT  
 SYSTEM.  
 DO NOT SCALE DRAWING  
 INTERPRET DRAWING PER ASME  
 14.5M 1994

UNLESS OTHERWISE SPECIFIED UNITS ARE MM	
.X DECIMALS	±.2
.XX DECIMALS	±.10
.XXX DECIMALS	±.010
ANGLES	±2°
INSPECTION DIM	○
PPAP DIM	◆

DRAWING DESCRIPTION			SCALE
<b>Ultron Retrofit 4 foot assembly</b>			
DRAWING NUMBER	REVISION	LIFE CYCLE STATUS	SIZE
	-A-NR	Editing	B
DRAWN BY		DRAWN DATE	SHEET
Ghalayini, Jana(Current by GE)		2017-05-31	3/4
APPROVED BY		APPROVED DATE	

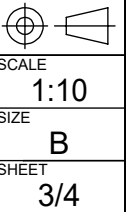

1

2

3

4

5

E

E

D

D

C

C





B

B

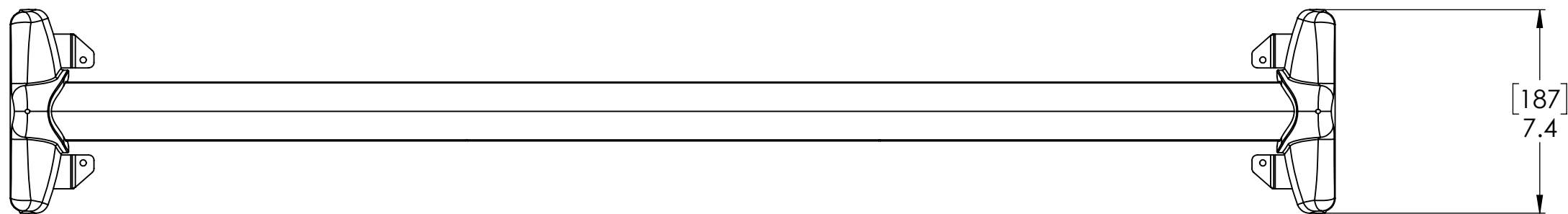
A

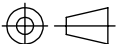
A



	<b>PROPRIETARY AND CONFIDENTIAL</b> THE INFORMATION CONTAINED IN THIS DRAWING IS THE SOLE PROPERTY OF <b>GE LIGHTING SOLUTIONS, LLC</b> 1940 ONÉSIME GAGNON LACHINE, QUÉBEC, CANADA H8T 3M6 ANY REPRODUCTION IN PART OR AS A WHOLE WITHOUT THE WRITTEN PERMISSION OF GE LIGHTING SOLUTIONS, LLC IS PROHIBITED.		UNLESS OTHERWISE SPECIFIED UNITS ARE MM		DRAWING DESCRIPTION <b>Ultron Retrofit 4 foot assembly</b>			
	THIS DOCUMENT IS ELECTRONICALLY SIGNED AND CONTROLLED IN A DATA MANAGEMENT SYSTEM. DO NOT SCALE DRAWING INTERPRET DRAWING PER ASME 14.5M 1994		.X DECIMALS ±.2 .XX DECIMALS ±.10 .XXX DECIMALS ±.010 ANGLES ±2° INSPECTION DIM  PPAP DIM 	DRAWING NUMBER DRAWN BY <b>Ghalayini, Jana(Current by GE)</b>		REVISION <b>-A-NR</b>	LIFE CYCLE STATUS <b>Editing</b>	
					DRAWN DATE <b>2017-05-31</b>		SIZE <b>B</b>	
					APPROVED BY 		SHEET <b>4/4</b>	

1

2

3

4

5