

Lumination™ LED Luminaires

TS Series Track Lights

TS Series Track Lights with reveal® Whiter White™ Technology



Project name _____

Date _____

Type _____

Product Description:

Lumination™ TS Series LED Track Lights are designed to deliver superior aesthetics, efficiency, and performance for retail accent lighting applications. These fixtures have a long rated life and deliver 90 lumens per watt (LPW) typical, allowing for lower maintenance and operating costs. Standard "Visual Comfort" lens minimizes glare while delivering up to 16,000 CBCP for high intensity accent lighting. Die-cast precision machined housings provide a unique and distinct aesthetic, while serving as an outstanding heat sink to regulate the LED temperatures for long life and minimal color shift. Lumination™ TS Series is also available with reveal® Whiter White™ technology. Ideal for retail accent lighting applications, this great technology delivers bright, crisp whites while also enhancing most other colors for a light experience like no other.

Performance Summary:

All performance claims are at 80 CRI, 3000K

Flood Version:

- 2200 lumen – 27 W
- 1750 lumen – 19.5 W
- 1300 lumen – 15 W
- 890 lumen – 10.3 W
- Flood (25°) and Wide Flood (35°) beam options

Spot Version:

- 1250 lumen – 20.6 W
- 14° beam
- 16,000 CBCP

reveal® Whiter White™ (WW) Version:

- 900 lumen - 19.5 W
- Spot (18°) and Flood (25°) beam options

Efficacy: 90 LPW Typical (flood version), 56 LPW Typical (spot version), 46 LPW Typical (Whiter White)

Input Voltage: 120V

CCT: 2700K/3000K/3500K (excludes Whiter White)

Typical CRI: 80 and 90 CRI options, 90 CRI (Whiter White)

Standard Dimming Controls: Non-dimming

Lifetime Rating: L70 @ 50,000 hours

Limited Warranty: 5 Years

Product Dimensions:

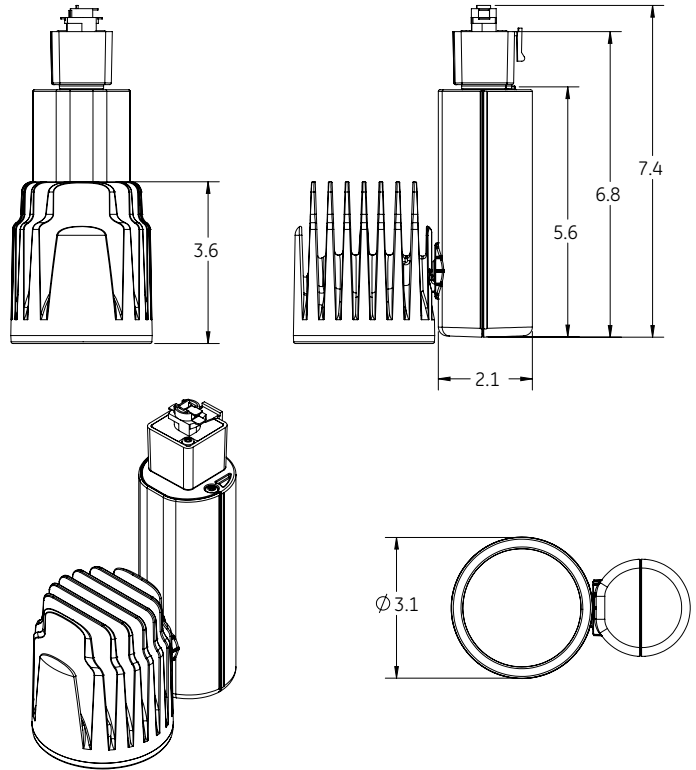

Certified by: 

a product of
ecomagination™

Ordering Information:

TS1

1V

TRACK HEAD	LUMEN PACKAGE	BEAM	CCT/CRI	HOUSING COLOR	TRACK ADAPTER	VOLTAGE	OPTIONS
TS1 = Lumination TS Series LED Track Light	L1 = 10.3 W-890 lm L2 = 15 W-1300 lm L3 = 19.5 W-1750 lm L4 = 27 W-2500 lm	FL = Flood (~25°) WF = Wide Flood (~35°)	827 = 80 CRI, 2700K 830 = 80 CRI, 3000K 835 = 80 CRI, 3500K 927 = 90 CRI, 2700K 930 = 90 CRI, 3000K	W = White B = Black S = Silver	G1 = Global, One Circuit (Compatible with Halo Track) G2 = TEK, Two Circuit, Two Neutral J1 = Juno, One Circuit (Compatible with Contech Track) L2 = Lightolier, Two Circuit	1V = 120V	(blank) = none HX = Hexcel Louver SN ² = Snoot
	S1 = 20.6 W-1150 lm	SP ¹ = Spot (~14°)					
	W1 = 19.5 W - 900 lm Whiter White	SP = Spot (~18°) FL = Flood (~25°)	WTW ² = Whiter White				

Ordering Notes:

1. S1 must use the SP (Spot) beam order code
2. W1 lumen packages should the WTW (Whiter White) CCT/CRI order code
3. SN and HX cannot be applied to same fixture

current
powered by GE



Lumination™ LED Luminaires

Lumen output varies based on CCT and CRI.

To estimate lumen output of the various CCT/CRI combinations, multiply 3000K, 80 CRI results by the following factors:

	11W Flood		15W Flood		19.5W Flood		20.6W Spot	
CCT	80CRI	90CRI	80CRI	90CRI	80CRI	90CRI	80CRI	90CRI
2700K	0.944	0.719	0.946	0.723	0.914	0.686	0.913	0.687
3000K	1.0	0.775	1.0	0.785	1.0	0.743	1.0	0.748
3500K	0.989	N/A	1.0	N/A	0.943	N/A	1.043	N/A

Photometric Data: TS Series Track Lights

11 Watt - 890 Lumen Flood Distribution - 21° Beam

CANDLEPOWER SUMMARY	
Angle	Candela
0	3855
5	3172
15	941
25	385
35	194
45	33
55	10

CONE OF LIGHT		
Height	fc	Dia. (ft.)
6'	107	2.2
8'	60	3.0
10'	39	3.7
12'	27	4.4
14'	20	5.2
16'	15	5.9

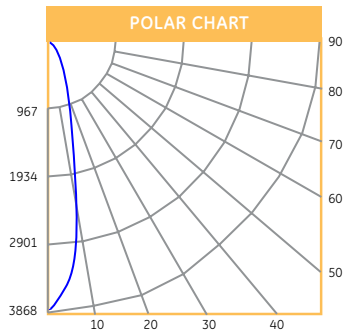

11 Watt - 890 Lumen Wide Flood Distribution - 29° Beam

CANDLEPOWER SUMMARY	
Angle	Candela
0	2578
5	2425
15	1188
25	403
35	170
45	14
55	4

CONE OF LIGHT		
Height	fc	Dia. (ft.)
6'	72	3.1
8'	40	4.1
10'	26	5.2
12'	18	6.2
14'	13	7.2
16'	10	8.3

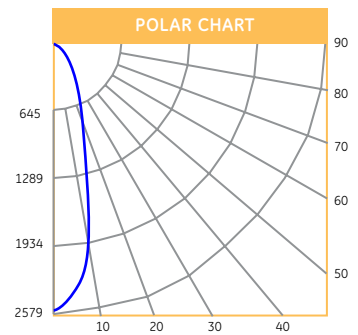

15 Watt - 1300 Lumen Flood Distribution - 24° Beam

CANDLEPOWER SUMMARY	
Angle	Candela
0	4954
5	4400
15	1570
25	550
35	270
45	40
55	10

CONE OF LIGHT		
Height	fc	Dia. (ft.)
6'	138	2.6
8'	77	3.4
10'	50	4.3
12'	34	5.1
14'	25	6.0
16'	19	6.8

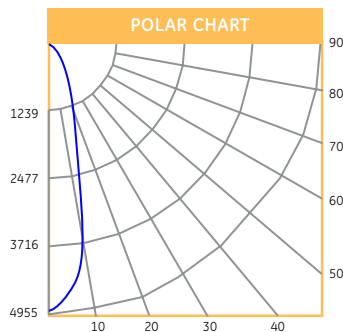

15 Watt - 1300 Lumen Wide Flood Distribution - 32° Beam

CANDLEPOWER SUMMARY	
Angle	Candela
0	3355
5	3150
15	1791
25	600
35	275
45	30
55	6

CONE OF LIGHT		
Height	fc	Dia. (ft.)
6'	93	3.4
8'	52	4.6
10'	34	5.7
12'	23	6.9
14'	17	8.0
16'	13	9.2

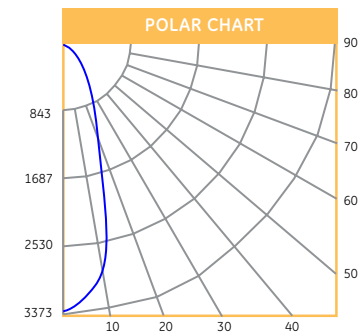

Lumination™ LED Luminaires

Photometric Data: TS Series Track Lights

19.5 Watt - 1750 Lumen Flood Distribution - 26° Beam

CANDLEPOWER SUMMARY	
Angle	Candela
0	5229
5	5089
15	2317
25	882
35	427
45	79
55	20

CONE OF LIGHT		
Height	fc	Dia. (ft.)
6'	145	2.8
8'	82	3.7
10'	52	4.6
12'	36	5.5
14'	27	6.5
16'	20	7.4

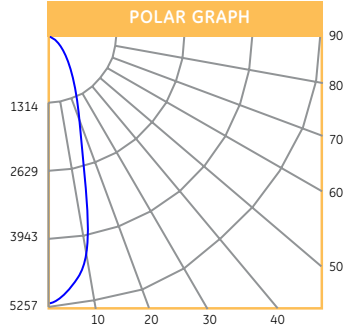

19.5 Watt - 1750 Lumen Wide Flood Distribution - 35° Beam

CANDLEPOWER SUMMARY	
Angle	Candela
0	3709
5	3620
15	2542
25	1082
35	408
45	67
55	15

CONE OF LIGHT		
Height	fc	Dia. (ft.)
6'	103	3.8
8'	58	5.0
10'	37	6.3
12'	26	7.6
14'	19	8.8
16'	14	10.1

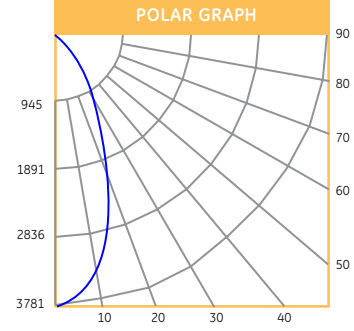

20.6 Watt - 1250 Lumen Spot Distribution - 14° Beam

CANDLEPOWER SUMMARY	
Angle	Candela
0	16656
5	11986
15	782
25	113
35	74
45	47
55	31

CONE OF LIGHT		
Height	fc	Dia. (ft.)
6'	463	1.5
8'	260	2.0
10'	167	2.5
12'	116	2.9
14'	85	3.4
16'	65	3.9

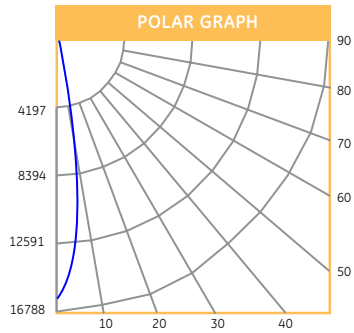

Lumination™ LED Luminaires

Photometric Data: TS Series Track Lights

19.5 Watt - Whiter White - 900 Lumen Spot Distribution - 18° Beam

CANDLEPOWER SUMMARY	
Angle	Candela
0	8493
5	5557
15	524
25	87
35	55
45	37
55	25

CONE OF LIGHT		
Height	fc	Dia. (ft.)
6	236	1.9
8	133	2.5
10	85	3.2
12	59	3.8
14	43	4.4
16	33	5.1

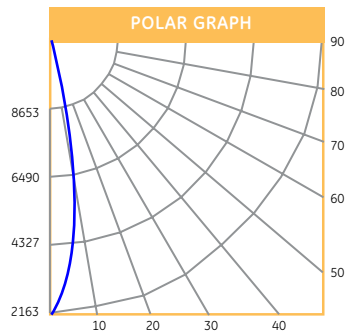

19.5 Watt - Whiter White - 900 Lumen Flood Distribution - 25° Beam

CANDLEPOWER SUMMARY	
Angle	Candela
0	4643
5	3997
15	1317
25	1670
35	57
45	39
55	26

CONE OF LIGHT		
Height	fc	Dia. (ft.)
6	129	2.7
8	73	3.5
10	46	4.4
12	32	5.3
14	24	6.2
16	18	7.1

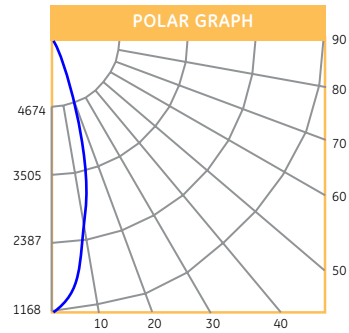

Product Specifications:

Construction:

- Die-cast and precision machined head
- 2-piece die-cast and precision machined driver compartment
- Textured powder coat finish
- Nylon lock washer firmly sets aiming angle

Installation:

- Track adapters easily twist into track systems for quick installation
- Compatible with several brands of track systems
- Several track system mounting and suspension options

Weight:

- 1.4 Lbs

Optical System:

- Visual Comfort lens reduces glare and eliminates pixilation
- Precision designed reflectors and diffusers for optimal efficiency
- Custom designed spot optical system optimizes CBCP

Electrical System:

- Integrated, high-efficiency LED driver
- Power factor > 0.9

For more information and access to all of our resources, including our design tool visit: www.gelighting.com